

QARDIO
TD-1261
Forehead
Thermometer



QARDIO TD-1261 Forehead Thermometer User Manual

[Home](#) » [QARDIO](#) » QARDIO TD-1261 Forehead Thermometer User Manual 

Contents

- [1 QARDIO TD-1261 Forehead Thermometer](#)
- [2 FAQ](#)
- [3 APPEARANCE AND KEY FUNCTIONS](#)
- [4 INTRODUCTION](#)
- [5 USING THE DEVICE](#)
- [6 RECALLING THE MEMORY](#)
- [7 REPLACING THE BATTERY](#)
- [8 CARE & CLEANING](#)
- [9 TROUBLESHOOTING](#)
- [10 SPECIFICATIONS](#)
- [11 FCC STATEMENT](#)
- [12 CONTACT](#)
- [13 Documents / Resources](#)
 - [13.1 References](#)

QARDIO

QARDIO TD-1261 Forehead Thermometer



Specifications

- **Part no.:** 311-1261500-XXX
- **Product name:** /CLEVER/1261E/EN/Qardio/
- **Dimensions:** L353*W250mm
- **Designer Color:** JF, K100, K75, L88.25*W125mm
- **Forehead Thermometer 311-1261500-XXX Version 2.0 2020/04 TD-1261**

FAQ

- **Q:** How do I clean the thermometer?
- **A:** Clean the thermometer with a soft cloth dampened with water and mild detergent. Do not immerse it in water or use abrasive cleaners.
- **Q:** Can this thermometer be used to measure room temperature?
- **A:** No, this thermometer is designed specifically for measuring human body temperature and should not be used for measuring room temperature.

APPEARANCE AND KEY FUNCTIONS

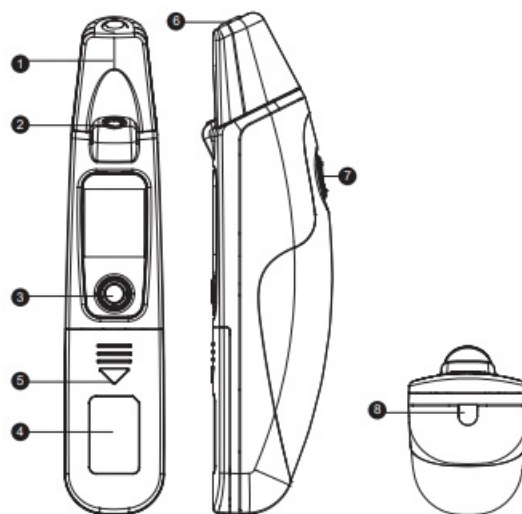

1. Probe cover
2. Night light

3. On/Memory button
4. Manufacturing label
5. Battery cover
6. Probe lens
7. Scan button
8. Bluetooth indicator

INTRODUCTION

Thank you for choosing the TD-1261 Forehead thermometer. This innovative medical device relies on advanced infrared (IR) technology to measure temperature instantly and accurately through the surface of the skin over the forehead. TD-1261 Forehead thermometer is an elegantly designed infrared thermometer meant for your family

INTENDED USE

- TD-1261 thermometer is an infrared thermometer intended for the measurement of human body temperature in people of all ages without contact to the body and may be used by medical professionals or by consumers in a home environment.

HOW DOES IT WORK

- The thermometer measures the infrared heat generated by the surface of the skin over the temporal artery. The thermometer then converts it into a temperature value shown on LCD.

IMPORTANT SAFETY INSTRUCTIONS

READ THIS BEFORE USING AND KEEP THESE INSTRUCTIONS

The following basic safety precautions should always be taken.

1. Close supervision is necessary when the thermometer is used by, on, or near children, handicapped persons or invalids.
2. Read this manual thoroughly and carefully before using it. Use the thermometer only for the intended use described in this manual.
3. Do not use the thermometer if it is not working properly, or if it has suffered any damage.
4. Do not use accessories that are not supplied or recommended by the manufacturer.
5. Proper maintenance is essential to the longevity of your device. If you are concerned about your accuracy of measurement, please contact the local customer service or place of purchase for help.
6. This device is a precision optical thermometer. Handle carefully and do not drop. Do not use if the thermometer has suffered damage.
7. This device is a non-sterile device. Do not use ethylene oxide gas, heat, autoclave, or any other harsh methods to sterilize the device

CAUTIONS AND WARNINGS

- As with any thermometer, proper technique is crucial to getting accurate temperature readings. Please read this manual thoroughly and carefully before using it.

- Always operate the thermometer in an operating temperature range 50°F to 104°F (10°C to 40°C), and with relative humidity less than 95%.
- Always store the thermometer in a cool and dry place: temperatures between -4°F to 140°F (-20°C to 60°C); relative humidity less than 95%. Avoid direct sunlight.
- Avoid dropping the thermometer.
- Do not disassemble the thermometer. Basic safety precautions should always be observed, especially when the thermometer is used on or near children and disabled persons.
- This thermometer is not intended to be a substitution for a consultation with your physician. The overhead scan temperature serves as a reference only. It cannot be a judgment on fever.
- Do not use if the thermometer has suffered damage.
- Do not place it on the replace, or near heating/cooling sources.
- Do not touch the lens

LCD SCREEN

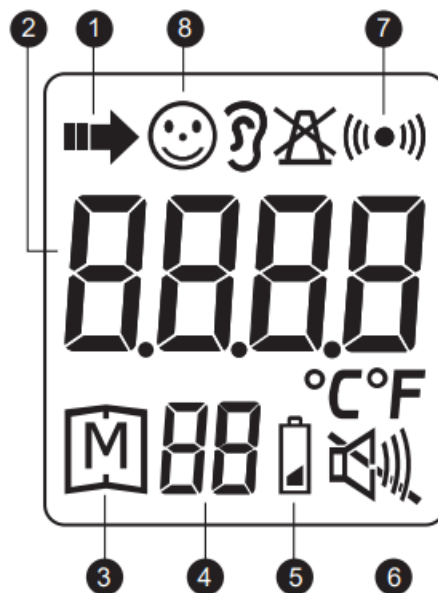

1. Temperature scanning in progress
2. Temperature display
3. Memory mode
4. Record numbers
5. Low battery indicator
6. Temperature unit
7. Communication symbol
8. Skin/Surface temperature indicator

USING THE DEVICE

Step 1 Turn on the thermometer.

Press and release the On / Memory button. The thermometer displays the last measurement.

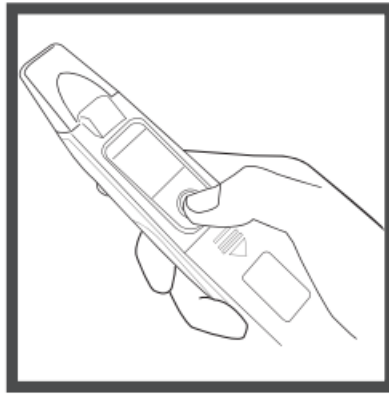

Step 2

Put the probe perpendicularly to the forehead. Press and hold the Scan button. Make sure the probe is perpendicular to the forehead, not at an angle

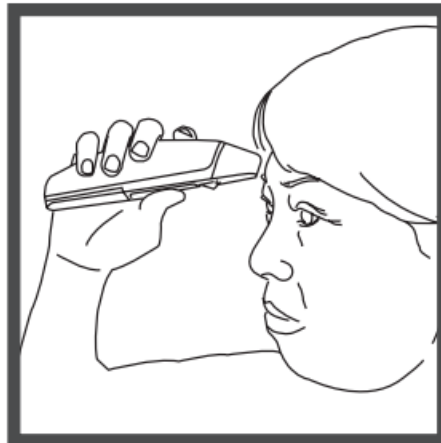

Step 3

Read the result. Release the button and read the result. “😊” is shown together with a temperature value and beeps.

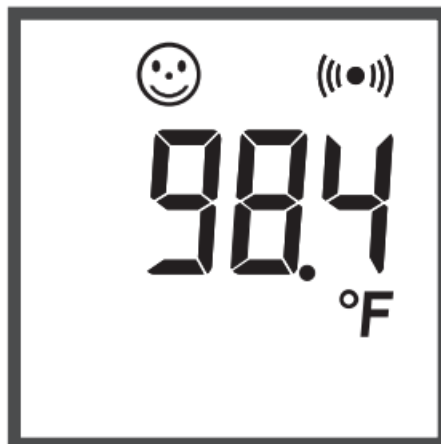

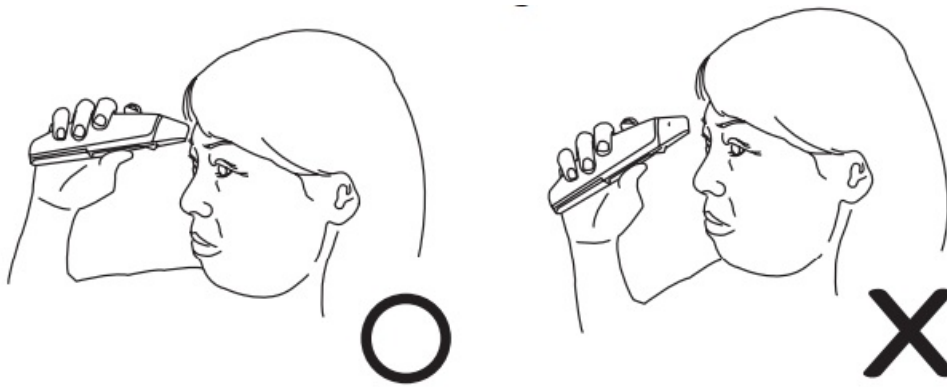

NOTE

- Please make sure that the forehead is clean before taking a measurement.
- If the probe is placed at an angle on the skin/surface scan, the reading will be affected by the surrounding temperature.
- You can perform a forehead scan from 3 cm away.
- Turn off the thermometer by pressing On / Memory button twice. Or leave for 3 minutes after a temperature measurement, the thermometer will automatically turn off. If you need to take another reading, wait “ ” flashing before taking
- another measurement.

HOW TO CHANGE THE TEMPERATURE UNIT

On the thermometer

Step 1

Keep pressing the scan button

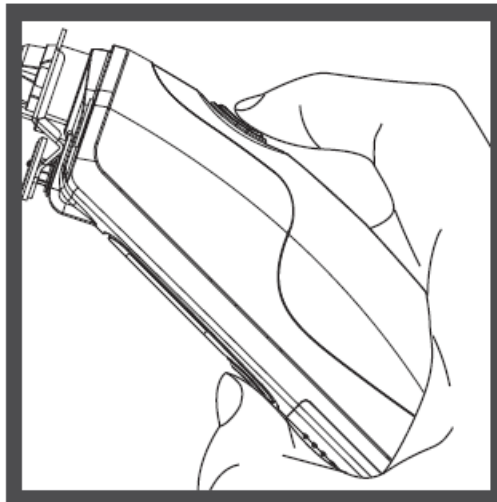

Step 2

Insert the battery while the scan button is pressed.

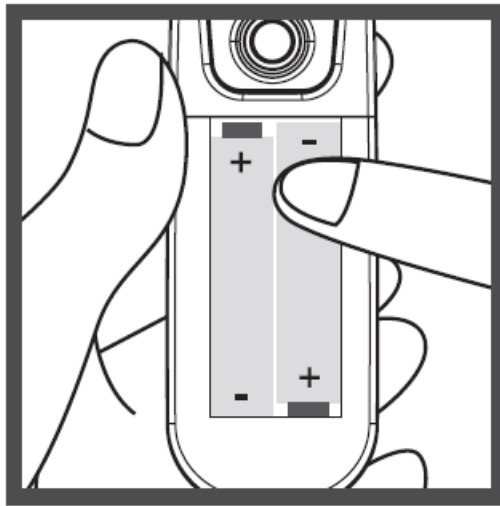

Step 3

Release the scan button after you see C (°C) or F (°F) on screen

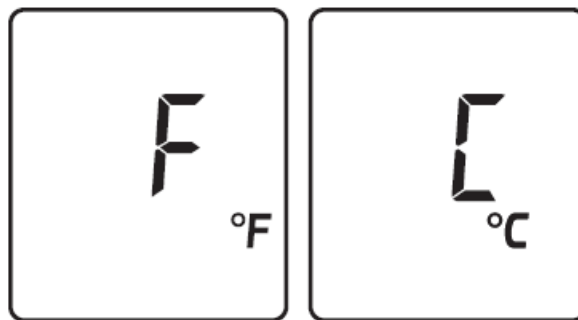

Step 4

Reattach the battery cover

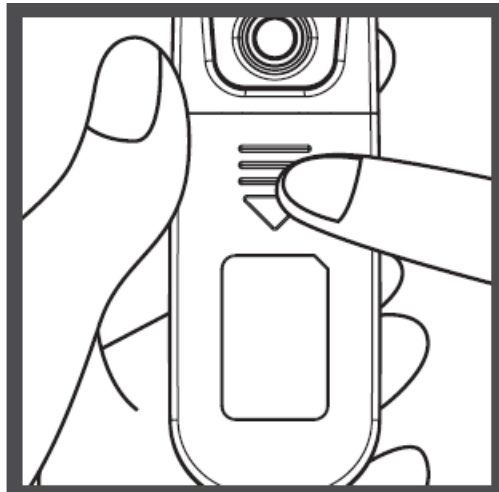

On the app

You can also change the temperature unit you will see on the app screen



Open settings in the Qardio App and select 'set up your thermometer'.

Then simply select the display unit and save.

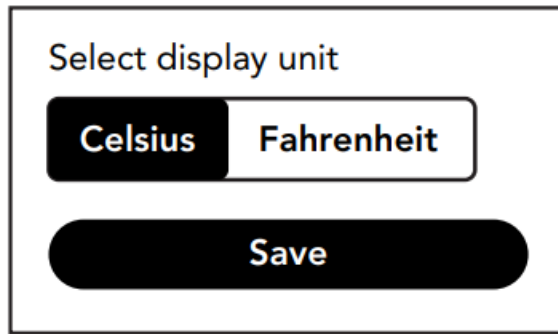

You will then see °C or °F on the app screen as per your selection



RESULT INDICATORS

Message	What it means
Lo Hi	<p>Temperature measurement outside the displayed temperature range, skin/surface scan temperature ranging from 71.6°F~111.2°F (22°C to 44°C), is shown on the display with red LED.</p> <ul style="list-style-type: none"> • Hi-temperature $\geq 111.3^{\circ}\text{F}$ (44.1°C) • Lo-temperature $\leq 71.5^{\circ}\text{F}$ (21.9°C)

RECALLING THE MEMORY

Your thermometer stores 10 recent readings in the memory

Step 1

Be sure the thermometer is OFF before recalling this memory

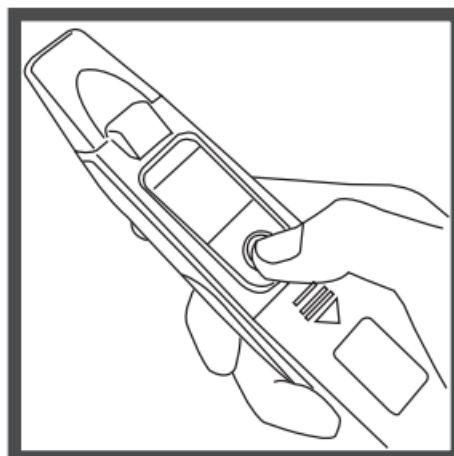

Step 2

Press the On / Memory button to turn on the thermometer

Step 3

Press the On / Memory button for 3 seconds to enter memory mode. Each time you press the On / Memory button,

a result will be displayed in the order of dates (latest result shown first), together with “” and number (from 1 to 10). When the memory is full, the new result will overwrite the oldest one. When you and the result on the display, press On / Memory button again to return to the first record.

Step 4

Exit the memory.

- Press the Scan button and the LCD will show the latest results by flashing “”. Then press On/Memory button again, and then the LCD will show “OFF” to exit the memory

TRANSMITTING DATA VIA BLUETOOTH

- You may transmit your temperature data from the meter to your device via Bluetooth. Please contact your local customer service or place of purchase for assistance.
- Please note that you must complete the pairing between the meter and Bluetooth receiver before transmitting data.

Pairing with your mobile device

1. Turn on the Bluetooth function on your mobile device.
2. Turn on the meter, and press and hold the On and Scan buttons simultaneously until “CLr” appears on the display. Your meter is now in pairing mode.
3. Follow the instructions on your app to pair the meter with your mobile device. (Ex. Search for the meter and then add it to app.)
4. After you successfully pair up the meter with your mobile device, the Bluetooth function of the meter will be activated automatically after each measurement. The meter is ready to transmit the data to your app.

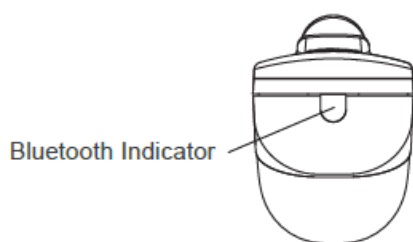

Bluetooth Indicator on the Thermometer

Bluetooth Indicator	Status
Flashing indicator	The Bluetooth function is on and waiting for connection.
Solid indicator	The Bluetooth connection is established.

WARNING

- While the meter is in transmission mode, it will be unable to perform a test.
- Make sure your device has the Bluetooth function turned on and the meter is within the receiving range before transmitting the data.

REPLACING THE BATTERY

The thermometer comes with two 1.5 V AAA alkaline batteries. Replace it when “” appears. Please follow the steps to replace new batteries.

Step 1

- Remove the battery cover.

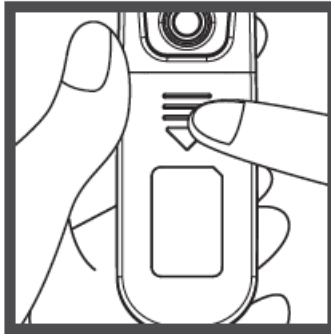

Step 2

- Place the new batteries in the battery compartment and press it in until the batteries are secured.

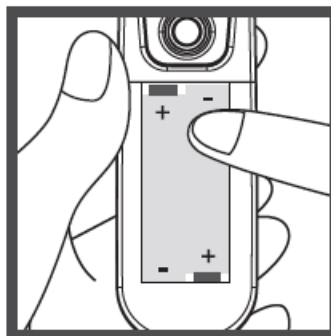

Step 3

- Reattach the battery cover.

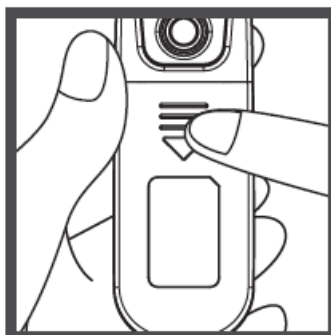

NOTE

- Although the thermometer works when “” appears, we still recommend that you change the batteries to obtain an accurate result.
- Remove the batteries if stored for a long period.
- The batteries should be kept out of children. If they are swallowed, promptly see a doctor for help.
- Properly dispose of the batteries according to your local environmental regulations.

ABOUT NORMAL BODY TEMPERATURE & FEVER

- Body temperature can vary from one individual/person to the next.
- It also varies by location on the body and time of day.
- Below are the statistical normal ranges from different sites.
- Please keep in mind that temperatures measured from different sites, even at the same time, should not be directly compared.
- Fever indicates that the body temperature is higher than normal.
- This symptom may be caused by infection, overdressing or immunization. Some people may not experience fever even when they are ill.
- These include but are not limited to, infants younger than 3 months old, persons with compromised immune systems, persons taking antibiotics, steroids or antipyretics aspirin/ibuprofen/acetaminophen, or persons with certain chronic illnesses.
- Please consult your physician when you feel ill even if you do not have a fever.

Table *1 Body Site Normal Temperature Range

Body Site	Normal Temperature Range
Oral	95.9°F – 99.5°F (35.5°C – 37.5°C)
Axillary (underarm)	94.5°F – 99.1°F (34.7°C – 37.3°C)
Rectal	97.9°F – 100.4°F (36.6°C – 38.0°C)
Ear	96.4°F – 100.4°F (35.8°C – 38.0°C)



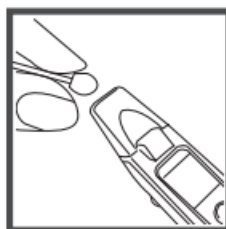

CARE & CLEANING

- Keep the probe lens clean, as grease buildup may affect the measurement.
- The probe is not waterproof. Please wipe with a clean and dry cotton swab to clean the probe on the inside.
- The body of the thermometer is not water-resistant. Never put the thermometer under a running tap or submerge it in water. Use a soft and dry cloth to clean it. Do not use abrasive cleaners.
- Store the thermometer in a cool and dry location. Free from dust and away from direct sunlight.

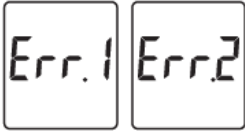

TROUBLESHOOTING

The table below shows problems you may encounter. All error messages below will be shown together with red backlight. Please follow “What to do” to resolve problems. If the problem still exists, please call your local dealer for help.

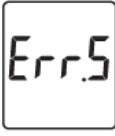
Message	What it means	What to do
	Appear when environmental temperature is below or above system operation range.	Put the thermometer under operating temperature range of 50°F to 104°F (10°C to 40°C)
	Problem with the thermometer.	Review the instructions and re-start the measurement procedure. If the problem persists, contact your dealer.
	Battery is low and "  "appears on LCD.	Please replace new batteries as soon as possible.
	Appears when the batteries can't provide enough power for a test.	Please replace new batteries immediately.

SPECIFICATIONS

- **Model no:** TD-1261
- **Dimension & Weight:** 162.2mm x 32.4mm x 38mm, 79g (without batteries)
- **Battery:** 2 x 1.5 V alkaline batteries
- **External output:** Bluetooth
- **Displayed temperature range:** 71.6°F~111.2°F (22°C to 44°C)
- **Display resolution:** 0.1°F / 0.1°C
- **Accuracy:** Meet the accuracy requirement specific to ASTM E1965-98

TEMPERATURE RANGE	ACCURACY
96.8°F to 102.2°F (36.0°C to 39.0°C)	±0.4°F (±0.2°C)
<96.8°F (36.0°C)	±0.5°F (±0.3°C)
>102.2°F (>39.0°C)	

- **Temperature unit:** °F/°C
- **Operating temperature range:** 50°F to 104°F (10°C to 40°C)
- **Operating humidity:** 95% RH or less
- **Storage temperature range:** -4°F to 140°F (-20°C to 60°C)
- **Storage humidity:** 95% RH or less
- **Memory capacity:** 10 measurements
- **Expected service life:** 3 years
- **IP classification:** IP22

REFERENCE STANDARDS

Device Standard

- Device Corresponds to the requirements of the standard for infrared thermometers
- ASTM E1965-98
- EN 12470-5
- EN 60601-1-2:2007/AC:2010
- EN 60601-1-4:1996
- EN 60601-1-6:2010

Electromagnetic Compatibility

- The device meets the stipulations of the standard EN 60601-1-2

FCC STATEMENT

FEDERAL COMMUNICATIONS COMMISSION (FCC) STATEMENT 15.21

Yespons auction comical cous void theaters at every so operate the equipment. 15.105 (b)

This equipment has been tested and found to comply with the limits for a Class B digital device, under part 15 of the FCC rules. These limits are designed to provide reasonable protection against harmful interference in a residential installation. This equipment generates, uses, and can radiate radio frequency energy and, if not installed and used under the instructions, may cause harmful interference to radio communications. However, there is no guarantee that interference will not occur in a particular installation. If this equipment does cause harmful interference to radio or television reception, which can be determined by turning the equipment on and on, the user is encouraged to try to correct the interference by one or more of the following measures:

- Reorient or relocate the receiving antenna.
- Increase the separation between the equipment and the receiver.
- Connect the equipment to an outlet on a circuit different from that to which the receiver is connected.
- Consult the dealer or an experienced radio/TV technician for help.

This device complies with Part 15 of the FCC Rules. Operation is subject to the following two conditions:

1. This device may not cause harmful interference and
2. This device must accept any interference received, including interference that may cause undesired operation of the device.

FCC RF Radiation Exposure Statement

1. This Transmitter must not be co-located or operating in conjunction with any other antenna or transmitter.
2. When used with an accessory that contains metal may not ensure compliance with FCC RF exposure guidelines.

CONTACT

- Distributed by: Qardio, Inc.
- 345 California Street
- Suite 600 & 700
- San Francisco, CA 94104
- support@getqardio.com
- Read instructions before use.

Documents / Resources

Name	311-1261500-XXX
Product ID	311-1261500-XXX
Part	311-1261500-XXX
Version	1.0
Date	2014-01-01

[QARDIO TD-1261 Forehead Thermometer](#) [pdf] User Manual
311-1261500-XXX, TD-1261, TD-1261 Forehead Thermometer, TD-1261, Forehead Thermometer, Thermometer

References

- [User Manual](#)

[Manuals+](#), [Privacy Policy](#)

This website is an independent publication and is neither affiliated with nor endorsed by any of the trademark owners. The "Bluetooth®" word mark and logos are registered trademarks owned by Bluetooth SIG, Inc. The "Wi-Fi®" word mark and logos are registered trademarks owned by the Wi-Fi Alliance. Any use of these marks on this website does not imply any affiliation with or endorsement.