

# VITAL SIGNS MONITOR

## OPERATOR'S MANUAL

Model: TD-2300B

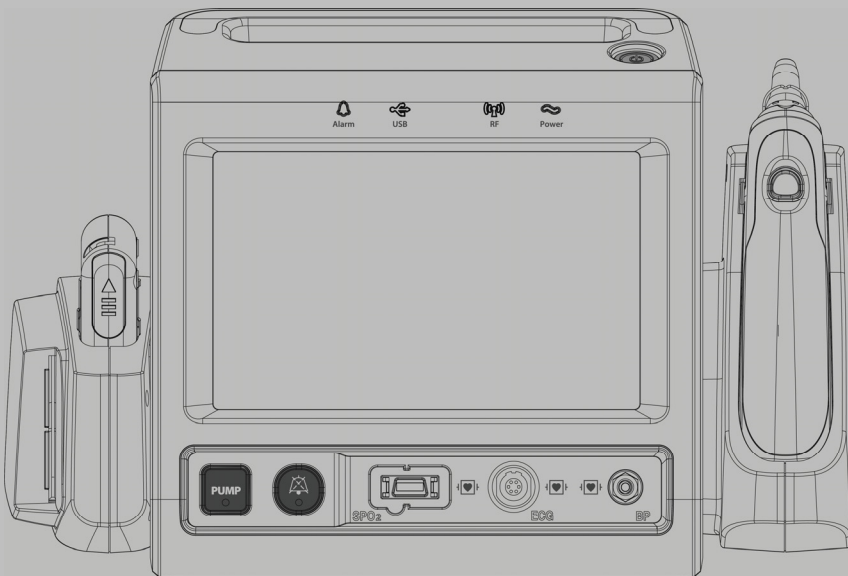

## About the Manual

The precautions, warnings and notes throughout this manual are very important. Please read this entire manual carefully before using the **TD-2300** Vital Signs Monitor.

# Table of Contents

<b>SAFETY INFORMATION</b>	<b>I</b>
General Warnings and Cautions	I
Blood Pressure Warnings and Cautions	IV
ECG Warnings and Cautions	V
SpO <sub>2</sub> Warnings	VI
Infrared Thermometer Warnings	VII
Blood Glucose Warnings	VIII
<b>INTRODUCTION</b>	<b>1</b>
Intended Use	1
Measurement Principles	1
Main Measurement Function	4
Contents of System	4
Monitor Overview	5
Before Measurement - Connecting Accessories	6
Monitor Main Display Area	12
Monitor Functions	18
<b>PERFORM MEASUREMENTS</b>	<b>54</b>
SpO <sub>2</sub> Measurement	54

<b>Blood Pressure Measurement</b>	<b>57</b>
<b>ECG Measurement</b>	<b>60</b>
<b>Blood Glucose Measurement</b>	<b>65</b>
Before You Begin	66
The Four Measuring Modes	70
Before Testing	71
Testing With Blood Sample	74
Maintenance	78
System Troubleshooting	83
Detailed Information	84
<b>Temperature Measurement</b>	<b>85</b>
Before You Begin	85
Using the Device	88
Recalling the Memory	90
Care & Cleaning	91
<b>ALARM AND MESSAGE</b>	<b>92</b>
<b>TAKING CARE OF THE MONITOR</b>	<b>95</b>
<b>Cleaning/ Disinfection</b>	<b>95</b>
Vital-Signs Monitor	95

Blood Pressure Cuff	95
Cables and Pressure Hose	95
Temperature Sensor	96
SpO <sub>2</sub> Sensor	96
<b>Battery Removal and Replacement</b>	<b>96</b>
<b>SpO<sub>2</sub> Accessory Disposal</b>	<b>97</b>
<b>ECG Accessory Disposal</b>	<b>97</b>
<b>Battery or Probe Cover disposal</b>	<b>97</b>
<b>Technical Assistance</b>	<b>98</b>
<b>ERROR MESSAGES</b>	<b>99</b>
<b>Blood Pressure Measurement Error Messages</b>	<b>99</b>
<b>SpO<sub>2</sub> Measurement Error Messages</b>	<b>99</b>
<b>Blood Glucose Measurement Error Messages</b>	<b>100</b>
<b>Ear Temperature Measurement Error Messages</b>	<b>101</b>
<b>SPECIFICATIONS</b>	<b>102</b>
<b>SYMBOL</b>	<b>108</b>
<b>IMPORTANT INFORMATION REGARDING ELECTRO MAGNETIC</b>	
<b>COMPATIBILITY (EMC)</b>	<b>110</b>

## SAFETY INFORMATION



### **WARNING!**

A warning statement in this manual identifies hazards that could lead to patient injury, illness, or death. These warnings pertain to the entire **TD-2300** Vital Signs Monitor.



### **CAUTION!**

A caution statement in this manual identifies hazards that could lead to minor personal injury, product damage, or property damage.

## General Warnings and Cautions

The information in this manual is a comprehensive guide to the operation of the monitor. For best results, read this manual thoroughly before using the monitor.



### **WARNING!**

Use this monitor only for the intended use described in this manual.



### **WARNING!**

The monitor is not intended for use without healthcare practitioner's continual attendance.



### **WARNING!**

If the monitor cannot take a measurement or the measurement readings seem dubious, check the condition of the patient first.



### **WARNING!**

If any abnormality is found in the patient or the monitor, take appropriate measures, such as stopping the monitor, to ensure the safety of the patient.



**WARNING!**

This monitor is not suitable to use around flammable anesthetic mixture with air or oxygen or nitrous oxide. An explosion may occur.



**WARNING!**

Do not let the monitor or its flexible cord come into contact with surfaces which are too hot to touch.



**WARNING!**

To ensure patient safety, use only the accessories and supplies (i.e., cuffs, hoses, temperature probes, SpO<sub>2</sub> probe, test strips, etc.) recommended for/or supplied with this monitor. Using unapproved accessories with this monitor can affect patient and/or operator safety.



**WARNING!**

Avoid water or any fluid from entering the connectors (especially AC power input socket). Should this occur, dry the connectors with a clean cloth immediately. For the monitor, remove the battery right away and do NOT turn on the monitor, then contact the customer service for assistance.



**WARNING!**

Use with the specified AC voltage and frequency.



**WARNING!**

Do not plug the AC adapter cable into an AC outlet (or unplug it) with wet hands.



**CAUTION!**

Every three months, inspect the blood pressure cuff, SpO<sub>2</sub> cable, and other accessories for fraying or other damage. Replace if necessary.



**CAUTION!**

Electric shock hazard: An operator may only perform maintenance procedures specifically described in this manual. For service, contact the customer service.



**CAUTION!**

This monitor complies with the current applicable standards for electromagnetic interference. As a precaution, avoid using this monitor close to other equipment.



**CAUTION!**

This monitor is composed of high-quality precision parts. Protect it from severe impact and shock. If it is dropped or damaged, it should be checked by a qualified service technician for proper operation prior to further use. Do not use this monitor if you notice any signs of damage. Contact the customer service for assistance.



**CAUTION!**

Do not use the SpO<sub>2</sub> probe with the blood pressure cuff simultaneously on the same limb. Doing so may result in inaccurate pulse rate and perfusion readings.



**CAUTION!**

Do not use the SpO<sub>2</sub> probe during a magnetic resonance imaging (MRI) scanning.



**CAUTION!**

The monitor is waterproof IPX2 degree. However, do not immerse it in water or drip fluids on heat exhale holes on the rear panel.



**CAUTION!**

When storage space is less than 20 records, the **TD-2300** will display the message to remind the user.

## Blood Pressure Warnings and Cautions

These warnings and cautions pertain to the blood pressure feature of this monitor.



**WARNING!**

Do not wrap the cuff around any of the following locations. Doing so can cause an accident. Anywhere on the four limbs that a venous pulse is secured, such as where there is an IV or blood transfusion, or any limb with an artificial dialysis shunt.



**WARNING!**

When the cuff hose is bent or blocked, there could still be air in the cuff even though the pressure display reads 0mmHg. This may block the blood flow in the arm, which may in turn cause peripheral function disorders. In addition, make sure the cuff is deflated before use.



**WARNING!**

Avoid compression of the blood pressure hose or cuff tubing. This may cause system errors to occur in the monitor.



**WARNING!**

This monitor does not operate effectively on patients who are experiencing convulsions or tremors.



**CAUTION!**

When several blood pressure measurements are taken on the same patient, regularly check the cuff site and extremity for possible ischemia, purpura, and/or neuropathy.



**CAUTION!**

Wrapping the cuff too loosely may lead to inaccurate results.

## ECG Warnings and Cautions



### **WARNING!**

In order to minimize interference and the danger of burns to the patient, only use ECG cables. Keep the ECG cable as far away as possible from any electrosurgical cables. Make sure that the electrosurgical return conductor (neutral) is properly attached to the patient and that a good contact is made.



### **Caution!**

The guidelines in this section are given as an overview only. They are not a substitute for, nor do they overrule manufacturers' documentation and instructions or departmental procedures.



### **WARNING!**

Danger of destroying the monitor during defibrillation! The monitor is type BF protected only when the original patient cables are used.



### **WARNING!**

Patients with a pacemaker must be observed continuously because the heart rate from the pacemaker might still be registered in case of a cardiac arrest or some arrhythmias.



### **WARNING!**

Pacemaker monitoring is not possible with ECG cables that have unshielded lead wires. Ensure that only shielded lead wire ECG cables are used when monitoring patients that have a pacemaker.



### **WARNING!**

It recommends to apply a SpO<sub>2</sub> sensor in addition to the ECG measurement and to set the alarm range for the peripheral pulse (PP) in the range of the heart rate (HR), or to set the HR source in the SpO<sub>2</sub> menu to SpO<sub>2</sub>.

## SpO<sub>2</sub> Warnings

These warnings and cautions pertain to the SpO<sub>2</sub> feature of this monitor.



**WARNING!**

The SpO<sub>2</sub> probe and extension cables are intended for use only for pulse oximeter measurements. Do not attempt to connect these cables to a PC or any other monitor.



**WARNING!**

Do not use a damaged probe or extension cables.



**WARNING!**

Incorrect application or extended use of a SpO<sub>2</sub> probe on the same sensor site may cause incorrect readings. Inspect the sensor site periodically as directed in the probe's directions for use.



**WARNING!**

Certain ambient environmental conditions, probe application errors, and certain patient conditions may affect SpO<sub>2</sub> readings and pulse signal.



**CAUTION!**

The SpO<sub>2</sub> probe is not intended for use as an apnea monitor.



**CAUTION!**

Do not immerse the probe or patient cables in water, solvents, or cleaning solutions (the sensors and connections are not waterproof).



**CAUTION!**

Do not use irradiation, steam, or ethylene oxide for sterilization.



**CAUTION!**

Consider the SpO<sub>2</sub> as an early warning monitor. As a trend toward patient deoxygenation is indicated, use laboratory instruments to analyze blood samples to completely understand the patient's condition.



**CAUTION!**

The Following Factors May Lead to Inaccurate Results:

- ▶ Excessive ambient light
- ▶ Excessive motion
- ▶ Anemia or low hemoglobin concentrations
- ▶ Fingernail polish
- ▶ Arterial catheters, blood and infusion lines, etc.
- ▶ Cardiovascular dyes
- ▶ Improper sensor use
- ▶ Incorrect sensor
- ▶ Electrosurgical interference
- ▶ Venous pulsations

## Infrared Thermometer Warnings



**CAUTION!**

Always store the thermometer in a cool and dry place: temperatures between -20 °C to 70 °C relative humidity less than 95%. Avoid direct sunlight.



**CAUTION!**

Avoid dropping the thermometer from a height or strongly hitting it with a hard object.



**CAUTION!**

Only use the probe covers provided by the manufacturer. For proper hygiene, do not share probe cover. Damaged probe cover may result in error display.



**CAUTION!**

Do not disassemble the thermometer.



**CAUTION!**

Basic safety precautions should always be observed, especially when the thermometer is used on or near children and disabled persons.



**CAUTION!**

This thermometer is not intended to be a substitution for consultation with your physician.



**CAUTION!**

Keep probe covers out of reach of children.



**CAUTION!**

Temperature of left and right ear may differ. Always measure the same ear.

## Blood Glucose Warnings



**WARNING!**

Carefully read the owner's manual of the blood glucose monitoring system before use.

# INTRODUCTION

## Intended Use

The monitor is intended to be used to monitor ECG, non-invasive blood pressure (systolic, diastolic and mean arterial pressure), pulse rate, body temperature, blood glucose and oxygen saturation of arterial hemoglobin (SpO<sub>2</sub>) for adult, pediatric, and neonatal patients. The monitor is intended to be used by clinicians and medically qualified personnel and trained users.

## Measurement Principles

### Blood Glucose Principle

The Blood Glucose Monitoring System measures the amount of sugar (glucose) in whole blood. The glucose testing is based on the measurement of electrical current generated by the reaction of glucose with the reagent of the strip. The meter measures the current, calculates the blood glucose level, and displays the result. The strength of the current produced by the reaction depends on the amount of glucose in the blood sample.

### Temperature Principle

TD2300 uses infrared thermometer to measure ear drum temperature as body temperature. An infrared thermometer is a thermometer which infers temperature from a portion of the thermal radiation sometimes called blackbody radiation emitted by the object being measured. By knowing the amount of infrared energy emitted by the object and its emissivity, the object's temperature can often be determined.

### Peripheral Capillary Oxygen Saturation (SpO<sub>2</sub>)

Peripheral capillary oxygen saturation (SpO<sub>2</sub>) of arterial hemoglobin is an estimation of the oxygen saturation level usually measured with a pulse oximeter device. It can be calculated with the pulse oximetry according to the following formula:

$$SpO_2 = \frac{HbO_2}{(HbO_2 + Hb)}$$

where

HbO<sub>2</sub> = Concentration of Oxygenated Hemoglobin

Hb = Concentration of Deoxygenated Hemoglobin

It was discovered in the 1860's that the colored substance in blood, haemoglobin, was also its carrier of oxygen, which the absorption of visible light by a haemoglobin solution varied with oxygenation. This is because the two common forms of the molecule, Oxygenated Hemoglobin (HbO<sub>2</sub>) and Deoxygenated Hemoglobin (Hb), have significantly different optical spectra in the wavelength range from 500nm to 1000nm. Therefore pulse oximeter determines SpO<sub>2</sub> value by measuring the absorption of red and infrared light passing through perfused tissue. Changes in absorption caused by the pulsation of blood in the vascular bed are used to determine oxygen saturation and pulse rate.

### **NIBP Oscillometric Principle**

The blood pressure is measured non-invasively at the upper arm by oscillometric method. The oscillometric method uses a sphygmomanometer cuff, like the auscultatory method, but with an electronic pressure sensor (transducer) to observe cuff pressure oscillations. Electronic pump and valve are equipped to automatically inflate and deflate the cuff. During a NIBP measurement, the cuff is inflated to a pressure initially in excess of the systolic arterial pressure and then slowly reduced to below diastolic pressure over a period of about 30 seconds. The inflated cuff detects the pulsation of the artery wall as a pressure vibration. The interpretation of these small variable amplitude vibrations provides a blood pressure value. The values of systolic and diastolic pressure are computed, not actually measured from the raw data, using an algorithm; the computed results are displayed. In practice, an algorithm and experimentally obtained coefficients are used to adjust the oscillometric results to give readings which match the auscultatory results as well as possible.

### **ECG Principle**

The ECG module detects and amplifies the tiny electrical changes on the skin that are caused when the heart muscle depolarizes during each heartbeat.

During each heartbeat, a healthy heart will have an orderly progression of a wave of depolarization that is triggered by the cells in the sinoatrial node, spreads out through the atrium, passes through the atrioventricular node and then spreads all over the ventricles. This is detected as tiny rises and falls in the voltage between two electrodes placed either side of the heart, which is displayed as a wavy line either on a screen or on paper. This display indicates the overall rhythm of the heart and weaknesses in different parts of the heart muscle.

In TD2300 five electrodes are used, and they can be combined into a number of pairs (For example: left arm (LA), right arm (RA), and left leg (LL) electrodes form the three pairs LA+RA, LA+LL, and RA+LL). The output from each pair is known as a lead. 5-lead ECGs tend to be monitored continuously and viewed only on the screen.

### **Heart Rate Measurement Principle**

TD2300 has three sources for heart rate measurement, followed by blood pressure measurement, blood oxygen measurement and electrocardiogram. They monitor the heartbeat's electrical signals, detect the apex of each heart contraction, record the interval time between the apex and the next apex, and then convert it into heart rate.

With each heartbeat transmitting an electronic signal to the monitor's electronic circuit system, a timing circuit is responsible for measuring the interval time between each heartbeat, averaging these interval time values over a short period of time, and converting it into heart rate reading for heartbeats per minute, because our heart is not a pendulum-like mechanism, the interval time values between heartbeats are different, so the heart rate monitor does not show its relatives with each heartbeat. If the heart rate is continuously expressed, then the heart rate numbers will change with each heartbeat. For example, if a person's average heart rate during exercise is 142 beats per minute, then the continuous reading should be 145, 141, 138, 143, 142, 147, 141, 137, 140, 144, etc., which changes with each heartbeat, it difficult to read and follow, in order to conquer this defect, heart rate monitor will take the average of a period of time, usually five to fifteen seconds, depending on the specification of the meter. So the heart rate monitor shows the average of each stage until the next time updating.

## Main Measurement Function

- NIBP (Non-Invasive Blood Pressure)
- SpO<sub>2</sub>
- Infrared Thermometer
- Blood Glucose Meter
- ECG

## Contents of System

- |  |                                   |
|--|-----------------------------------|
| 1. Main monitor                                | 10. AC power cord                 |
| 2. Infrared thermometer                        | 11. Instruction card              |
| 3. Probe cover of infrared thermometer         | 12. Warranty card                 |
| 4. Blood glucose meter                         | 13. ECG electrode pads (5 pieces) |
| 5. Blood glucose test strip (10 strips)        | 14. SD memory card                |
| 6. Safety lancet (10 pieces)                   | 15. Probe cover cassette          |
| 7. SpO <sub>2</sub> sensor and extension cable |                                   |
| 8. ECG cable                                   |                                   |
| 9. NIBP upper arm cuff and extension hose      |                                   |

## Monitor Overview

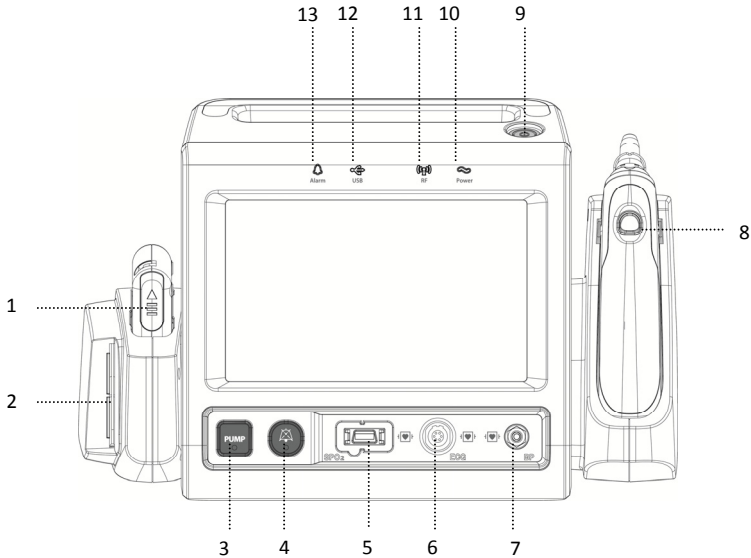

1. Blood glucose meter
2. Smart card reader
3. Non-invasive blood pressure (NIBP) measurement button  
(When PUMP LED lights up, you can press the button to start a NIBP measurement. You can also press this button for emergency stop during the measurement.)
4. Silence button  
(When the alarm is sounding, press this button to temporarily mute it, audio paused. Refer to page 93 for related settings.)
5. SpO<sub>2</sub> sensor connection port
6. ECG cable connection port
7. NIBP pressure hose connection port
8. Infrared thermometer
9. Power On/Off button
10. Power display LED
11. RF LED
12. USB LED
13. Alarm LED

## Before Measurement - Connecting Accessories

Start with the monitor off, and connect all accessories to the monitor. Please find the connection ports from page 10.

**Note:**

- ▶ The figures are just for reference. Actual accessories may differ.

Accessories of TD-2300 include:

1. SpO<sub>2</sub> finger sensor and extension cable

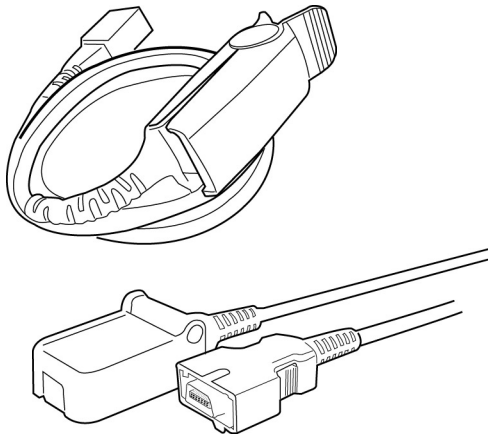

**Note:**

- ▶ Sensors of adults / pediatric patients / and neonates are different. Be sure to read the package printings and use a correct sensor.
- ▶ If you are going to change the sensor, make sure you choose the corresponding brand to your model.
- ▶ In case you have to use a different brand, please consult your agent first.

2. NIBP pressure cuff and hose

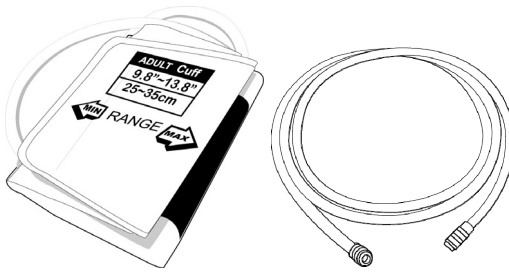

3. ECG cable

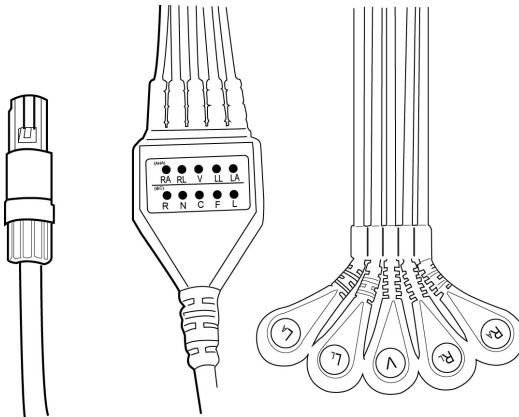

**Note:**

- ▶ This monitor can adapt 3 leads or 5 leads ECG cable.
- ▶ Color code: the colors shown here are according to IEC requirements.

4. Barcode scanner (Optional)



## 5. AC power cord

For example: American specification and European specification.

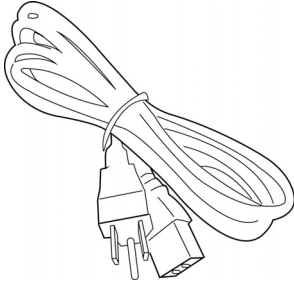

AC power cord (American specification)



AC power cord (European specification)

### Note:

- ▶ Without this item, the monitor can still work until the battery is out of electricity
- ▶ There are different specifications of AC power cord for different countries. Make sure you use the correct one for your country.
- ▶ This AC power cord can recharge the battery. It takes approximately 5 hours for the battery to get fully recharged.
- ▶ Make sure to use the American specification cord or European specification cord accordingly to the voltage of the country.

6. Rolling stand (Optional)

(This stand is for moving the monitor conveniently. The monitor still works well without this stand.) Refer to rolling stand manual.

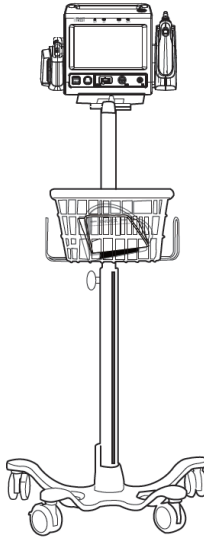

### Connection Ports in the Front Panel

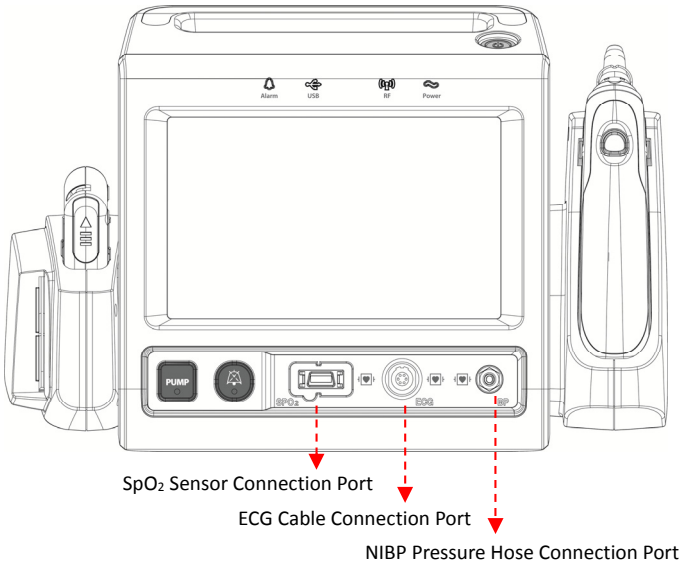

### Connection Ports in the Back

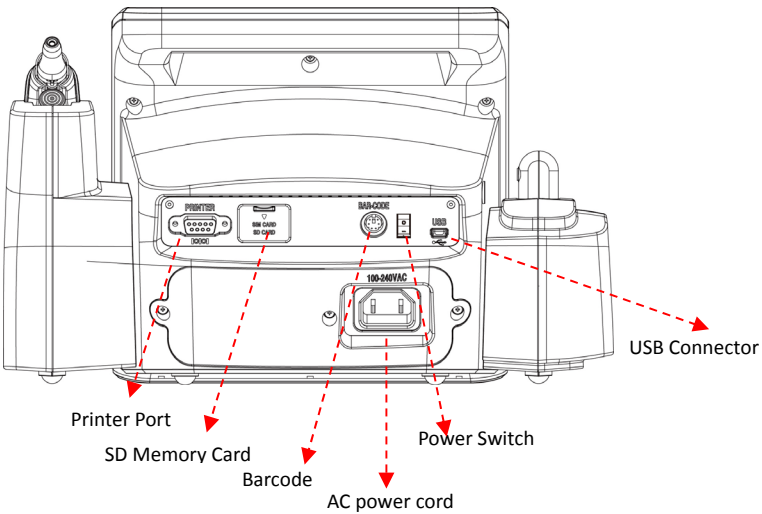



**Caution!**

Make sure that all accessories are **securely** connected to monitor before performing any test, or it may cause inaccurate results.

**Note:**

- ▶ Before taking measurements, please **pair up the glucose meter** (please refer to page 35) and **infrared thermometer** (please refer to page 37) with the monitor and make sure **the cuff is completely evacuated**.
- ▶ Use only recommended accessories with the monitor.
- ▶ The monitor is equipped with a Lithium-ion rechargeable battery. When using the monitor for the first time or the battery is low, connect the monitor to a power source and charge the battery. It takes approximately 5 hours to be fully charged.

## Monitor Main Display Area

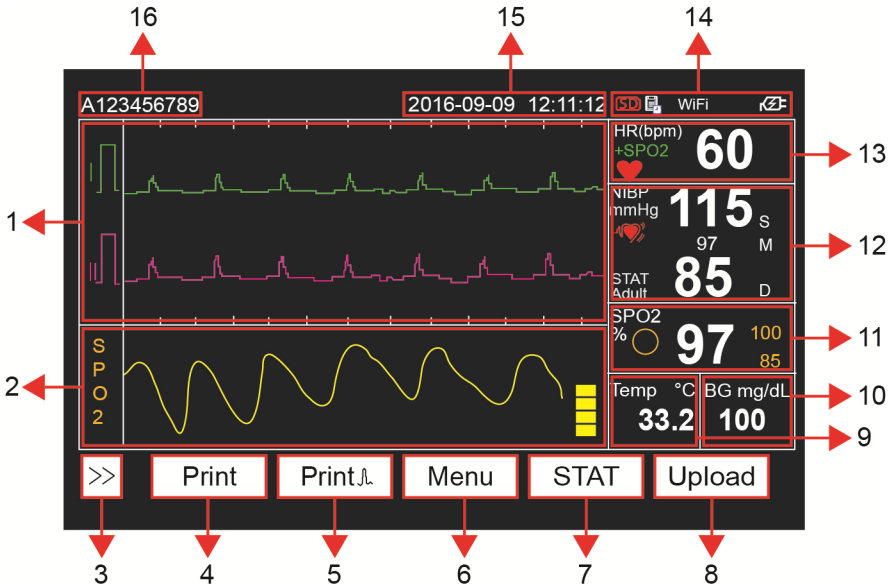



	Area	Description
1	ECG display area	Display ECG-related info
2	SpO <sub>2</sub> display area	Display SpO <sub>2</sub> -related info
3	>> button	Display ECG-different channel
4	Print button	Touch this button to print out the readings.
5	Print  button (ECG)	Touch this button to save the ECG data and to print out the ECG waveforms
6	Menu button	Touch this button to change settings
7	STAT button	Touch this button for a 5-min consecutive NIBP measurement.
8	Upload button	Transfer data via Wi-Fi (for Wi-Fi models only).
9	Temperature display area	Display temperature-related info
10	Blood glucose display area	Display blood-glucose-related info
11	SpO <sub>2</sub> display area	Display SpO <sub>2</sub> -related info
12	NIBP display area (Arrhythmia)	Display NIBP-related info (Detect the heart beats with an irregular rhythm and display the icon)
13	Heart rate display area	Display heart-rate-related info
14	Status indicator display area	Display status indicators

15	Date / Time	Display date and time You may key in the date and time.
16	Patient's ID	Display the patient's ID.

For details, please refer to the following sections.

**Note:**

- ▶ For SpO<sub>2</sub> display area, you can directly touch the area for saving. While touching the related SpO<sub>2</sub> area, the SpO<sub>2</sub> character next to the waveform display area will turn to flash one time, and the SpO<sub>2</sub> reading will be recorded.
- ▶ For ECG display area, touch the waveform on the display and a saving button  will appear on the lower-left corner, press  for saving the ECG reading.
- ▶ For SpO<sub>2</sub> or ECG display area, you can directly touch the SpO<sub>2</sub> or ECG related areas for saving. The remaining areas: the readings of NIBP, BG and Temp will be saved automatically upon appearing on the display.
- ▶ When a reading exceeds the set alarm limit, the reading turns red.
- ▶ If the time and date display on the main screen shows red, which indicates an error appeared. Please switch off the power switch in the back of monitor. After waiting for 2 minutes, re-switch it on.

1. ECG display area

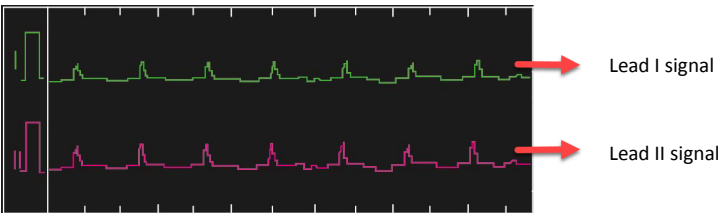

## 2. SpO<sub>2</sub> display area

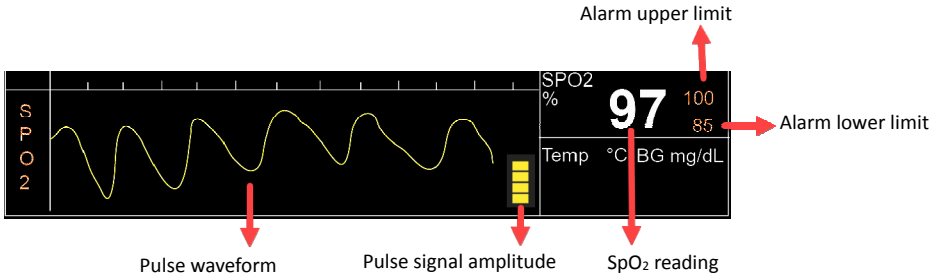

### Note:

- ▶ When the sensor is disconnected, the waveform disappears; the SpO<sub>2</sub> reading remains for 30 seconds and then disappears.

## 3. button

Display ECG-different channel.

## 4. Print button

Touch this button to print out the readings. Please refer to page 18.

### Note:

- ▶ When you touch this button, the monitor beeps. However, the monitor does not detect whether a printer is connected. Please make sure the printer is well connected.

## 5. Print button (ECG)

Touch this button to save the ECG data and to print out the ECG waveforms.

### Note:

- ▶ When you touch this button, the monitor beeps. However, the monitor does not detect whether a printer is connected. Please make sure the printer is well connected.

6. **Menu button**

Touch this button to enter setup menu. Please refer to page 19.

7. **STAT**

Touch this button for a 5-min consecutive NIBP measurement.

8. **Upload button**

Transfer data via Wi-Fi (for Wi-Fi model only).

9. **Temperature display area**

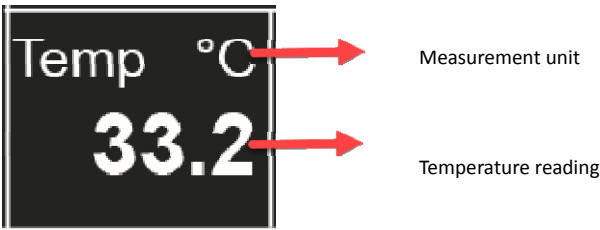

10. **Blood glucose display area**

Infrared thermometer

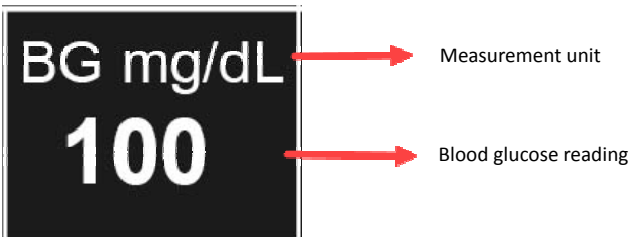

**11. SpO<sub>2</sub> display area**

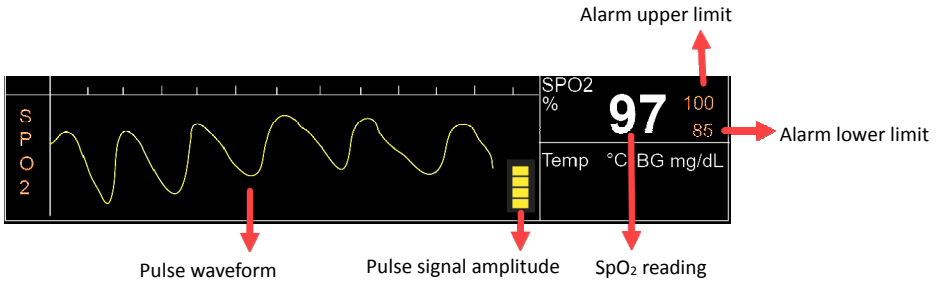

**Note:**

- ▶ When the sensor is disconnected, the waveform disappears; the SpO<sub>2</sub> reading remains for 30 seconds and then disappears.

**12. NIBP display area**

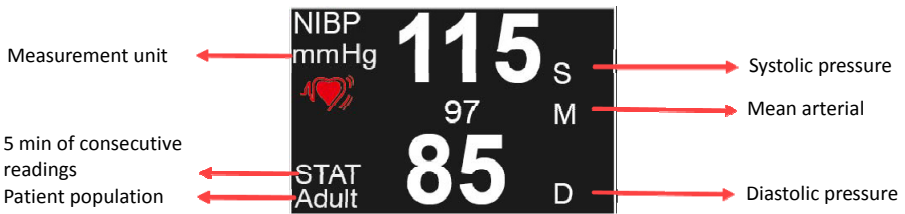

**13. Heart rate display area**

When the setting is "AUTO", the "+" will appear

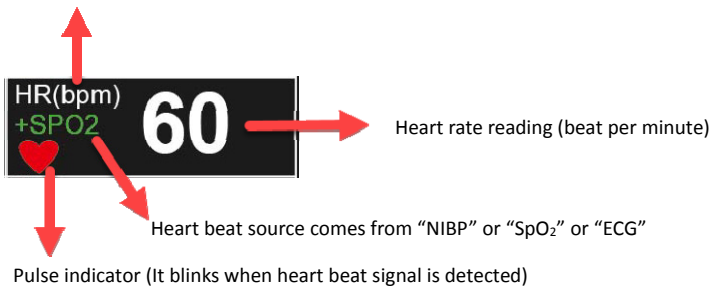

#### 14. Status indicator area



This indicator displays when the symbol is blinking, that the SD memory card slot is waiting for plug.



This indicator displays when you turn on Auto Save function. Please refer to page 27.



This indicator displays when you turn on Printing function. Please refer to page 18.



This indicator displays when you turn on Bluetooth. Please refer to page 39.



This indicator displays when the “Lighting” symbol is constantly shown, the device has been recharging.



This indicator displays when the “Lighting” symbol disappears, that the device has been recharged completely.



This indicator displays when you turn on Wi-Fi.

Battery indicator: the percentage means the power storage capacity



Green: 41%~100% (power normal)



Yellow: 21%~40% (power low)



Red: 0%~20% (power very low)

When the bar turns to red, the information signal makes a long sound every 10 seconds (till the monitor automatically turns off).

#### **Note:**

- ▶ The stored data will not be deleted, if the monitor automatically turns off.
- ▶ Every 10 seconds, TD-2300 would record the number of Heart rate and SAT value and the time. TD-2300 will overwrite the old record instead of the new record if the old was recorded 10 seconds ago. If not, TD-2300 will append the new record at the end of the last old record. So the recorded file will show every power-failure time.

## 15. Date / Time area

Please refer to page 32 to change date and time.

## 16. Patient's info of measurement

You can name the Patient's ID where you perform the measurements. Please refer to page 20.

## Monitor Functions

After all accessories are well connected, power on the monitor and you can proceed with measurement or enter each mode by touching the screen.

### Print

The Print Function provides options for printing out data. Touch the "Print" button and the printer will print out the readings. Please use printers that are designed for TD-2300.

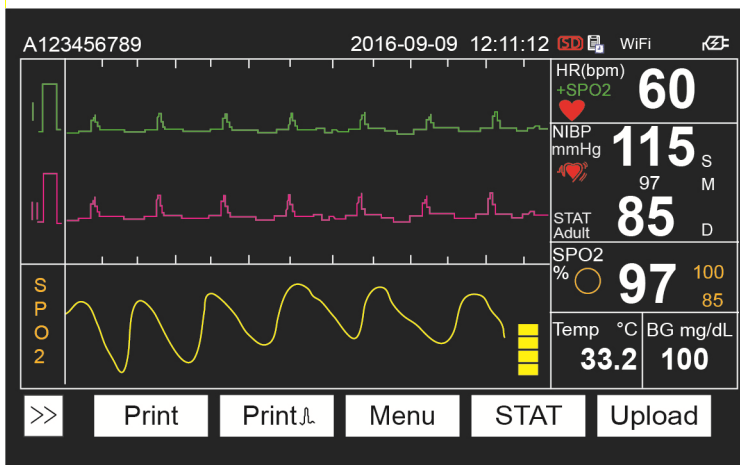

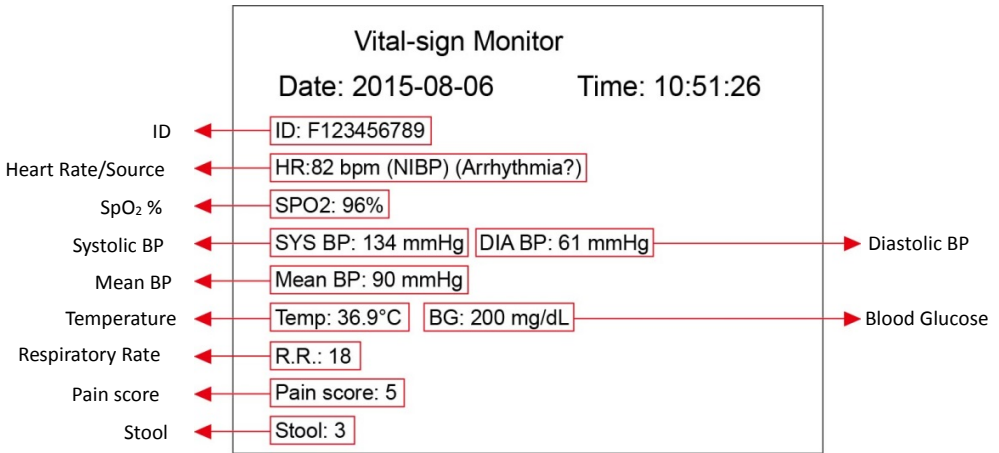

### Print

The Print  Function provides options for printing ECG waveform. Touch this button to save the ECG data and to print out the ECG waveforms. Please use printers that are designed for TD-2300.

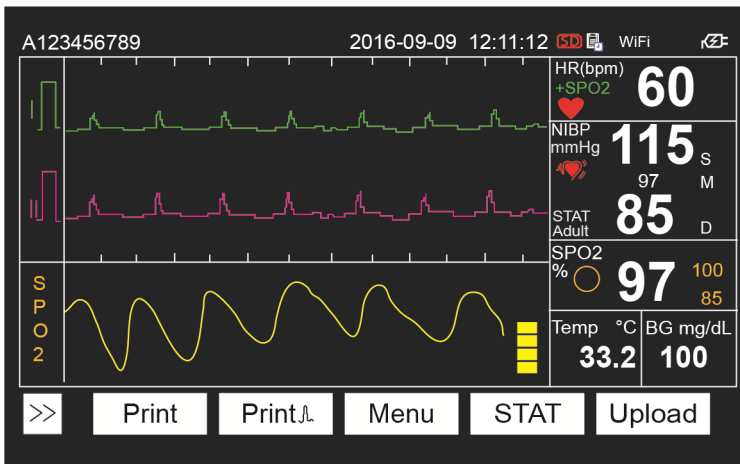

### Menu

The Menu function allows system configurations to be adjusted. Touch the Menu button to enter the setting windows. Read the following contents for descriptions.

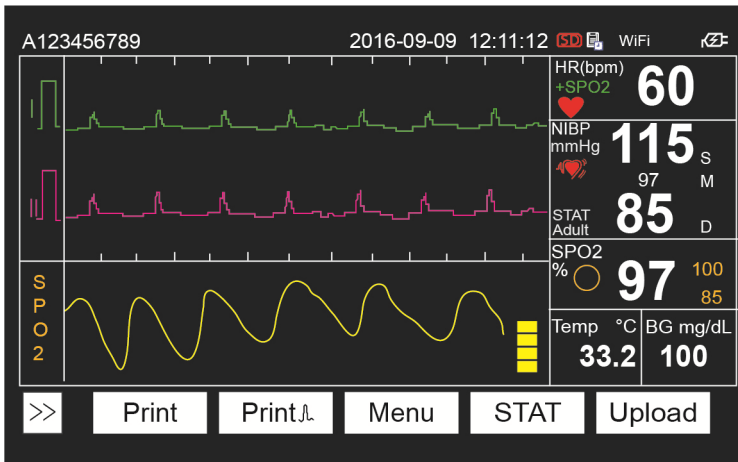

**Note:**

- ▶ During the period from power failure to recovery within 30 seconds, it's no need to reset the monitor.

**ID**

Input Patient ID, height, weight, and clinician ID. Touch the info areas to enter the key-in windows.

**Save:** Touch "Save" to save the changes. (If no changes, "Save" is in gray and does not function)

**Exit:** Touch "Exit" to exit this page.

<b>ID</b>	NIBP	SPO2	EXT	Mem	SYS	MSG	ECG
■ Patient ID	A123456789						
■ R.R.	0	■ Pain score	0	■ Stool	0		
■ Height	170	cm	■ Age	40			
■ Weight	60	Kg	■ Gender	Female			
■ Clinic ID	Clinic						
Save		Menu			Exit		

- **Gender**

Touch the “Gender” button and Select the male or female

- **Patient ID**

Touch the numbers and letters to key in. Touch “Enter” to confirm the ID. You can also use a barcode scanner to input the Patient ID. Touch “Exit” to exit this page without saving. By scanning the patient ID, the patient data saved before can be retrieved and displayed.

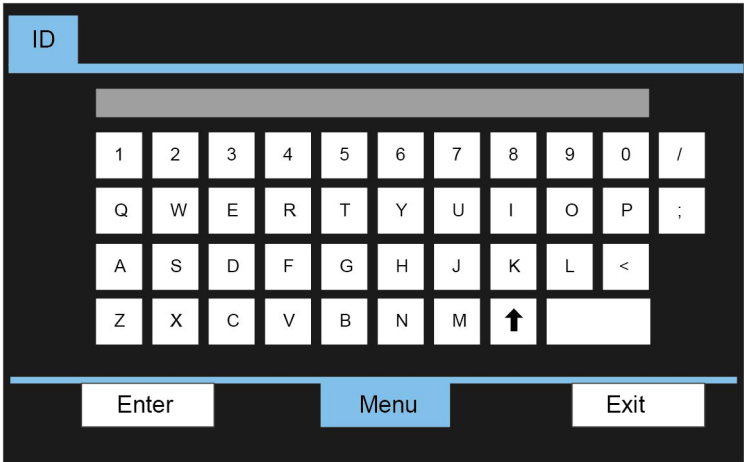

- **Age**

Touch the numbers to key in. Touch “OK” to confirm the age number. Touch “C” to clear the display area to “0”. Touch “Exit” to exit this page without saving.

Input range: 0~200 (If out of this range, touching “OK” does not function.)

The screenshot shows a user interface for entering an age. At the top left, there is a blue box labeled "ID". Below it, the word "Age" is displayed. To the right of "Age" is a numeric keypad. The keypad has a display area at the top showing "0" and a range "0~200". The keypad buttons are arranged as follows:

1	2	3	OK
4	5	6	
7	8	9	C
0			Exit

At the bottom center, there is a blue box labeled "Menu".

- **Height**

Touch the numbers to key in. Touch “OK” to confirm the height number. Touch “C” to clear the display area to “0”. Touch “Exit” to exit this page without saving.

Input range: 0~999.9 (cm) (If out of this range, touching “OK” does not function.)

The screenshot shows a user interface for entering a height. At the top left, there is a blue box labeled "ID". Below it, the word "Height" is displayed. To the right of "Height" is a numeric keypad. The keypad has a display area at the top showing "0" and a range "0~999.9". The keypad buttons are arranged as follows:

1	2	3	OK
4	5	6	
7	8	9	C
0			Exit

At the bottom center, there is a blue box labeled "Menu".

- **Weight**

Touch the numbers to key in. Touch “OK” to input the weight number. Touch “C” to clear the display area to “0”. Touch “Exit” to exit this page without saving.

Input range: 0~999.9 (kg) (If out of this range, touching “OK” does not function.)

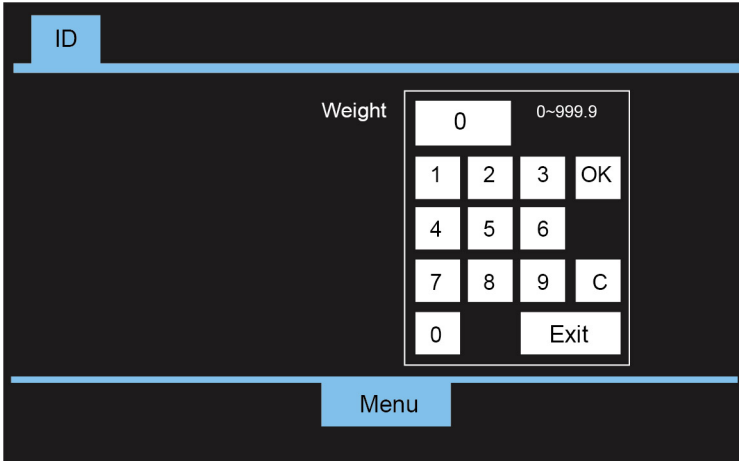

- **Clinician ID**

Touch the numbers and letters to key in.

Touch “Enter” to confirm the Clinician ID. You can also use a barcode scanner to input the Clinician ID.

Touch “Exit” to exit this page without saving.

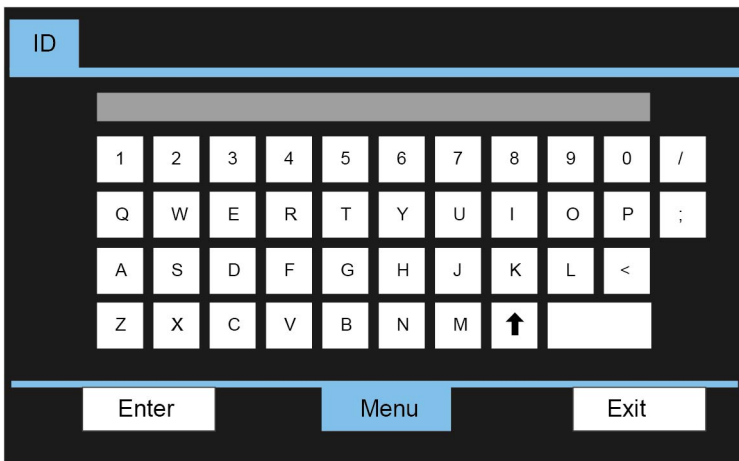

- **R.R.**

Touch the numbers to key in. Touch “OK” to confirm the R.R. number. Touch “C” to clear the display area to “0”. Touch “Exit” to exit this page without saving.

Input range: 0~99 (min) (If out of this range, touching “OK” does not function.)

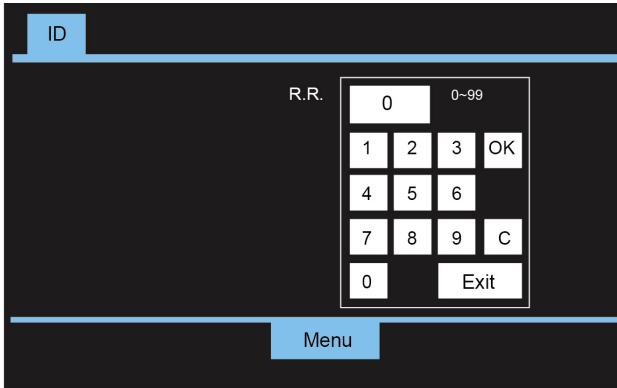

- **Pain score**

Touch the numbers to key in. Touch “OK” to confirm the pain score number. Touch “C” to clear the display area to “0”. Touch “Exit” to exit this page without saving.

Input range: 0~10 (If out of this range, touching “OK” does not function.)

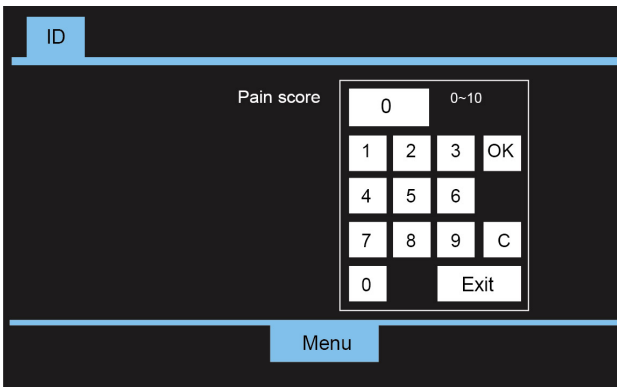

- **Stool**

Touch the numbers to key in. Touch “OK” to confirm the stool number. Touch “C” to clear the display area to “0”. Touch “Exit” to exit this page without saving.

Input range: 0~99 (If out of this range, touching “OK” does not function.)

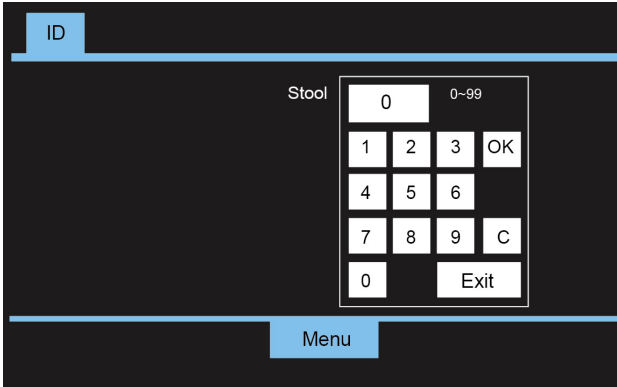

### **NIBP**

Set up the non-invasive blood pressure function.

**Save:** Touch “Save” to save the changes. (If no changes, “Save” is in gray and does not function)

**Exit:** Touch “Exit” to exit this page.

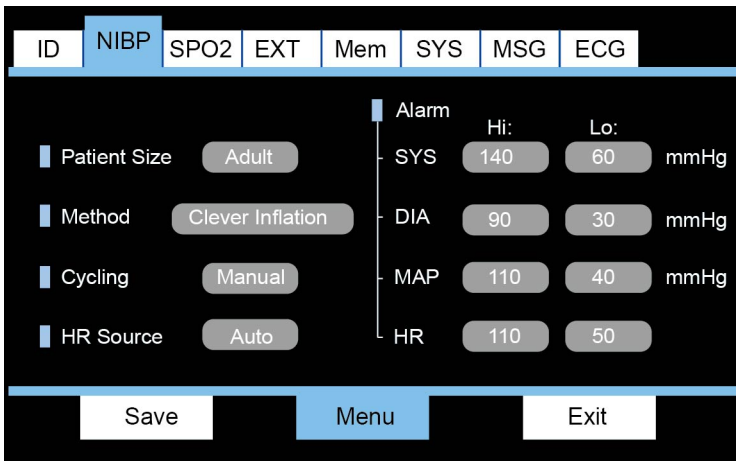

The settings are described as below.

	NIBP Setting	Description
<b>Patient</b>	Neonate	Select the patient population accordingly.
	Pediatric	
	Adult (default)	
<b>Method</b>	Clever Inflation (default)	If interfered during the first measurement, the monitor will then take a measurement again.
	Deflation Only (for neonate)	Take a measurement only during inflation
<b>Cycling</b>	OFF(default)	Take a measurement only when you press <b>PUMP</b> button.
	3 min	
	5 min	
	10 min	
	15 min	
	30 min	
	1 Hr.	
	1.5 Hr.	
	2 Hr.	
4 Hr.		
<b>HR Source</b>	Auto(default)	The monitor automatically switches to a stable heart rate.
	SpO <sub>2</sub>	Take the pulse rate from SpO <sub>2</sub> measurement.
	NIBP	Take the pulse rate from blood pressure measurement.
	ECG	Take the pulse rate from ECG pressure measurement.

Alarm type	Hi:	Lo:	Description
<b>SYS</b>	275 ~ 61	139 ~ 50	When any reading exceeds its limit, the reading turns yellow.
<b>DIA</b>	200 ~ 31	89 ~ 20	
<b>MAP</b>	225 ~ 41	109 ~ 30	
<b>HR</b>	250 ~ 51	109 ~ 20	

## SpO<sub>2</sub>

Set up the SpO<sub>2</sub> function.

**Save:** Touch “Save” to save the changes. (If no changes, “Save” is in gray and does not function)

**Exit:** Touch “Exit” to exit this page.

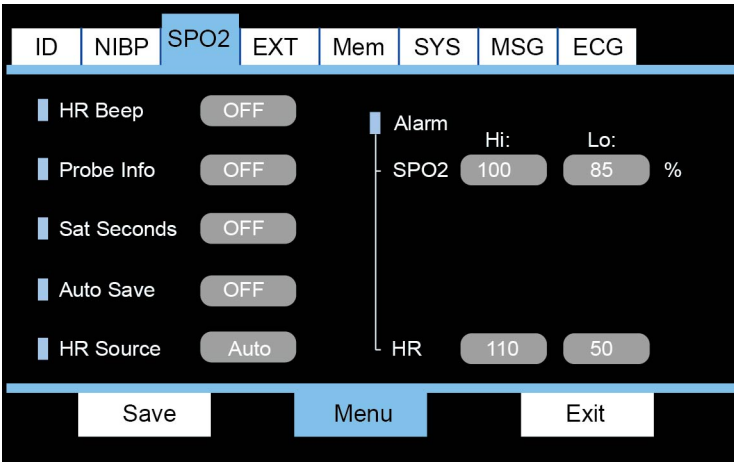

The settings are described as below.

	SpO <sub>2</sub> Setting	Description
<b>HR Beep</b>	On	The monitor beeps as the pulse goes.
	Off (default)	The monitor does not beep along with the pulse.
<b>Probe Info</b>	On	The monitor beeps when: <ol style="list-style-type: none"> <li>The probe is disconnected.</li> <li>The sensor cannot receive signals while taking a measurement.</li> </ol>
	Off (default)	The monitor does not beep with the probe conditions.
<b>Auto Save</b>	Off (default)	The monitor will save each reading according to the selected interval setting.
	1 min	
	5 min	
	10 min	

<b>Sat Seconds</b>	Off (default)	Setting for Sat Seconds Alarm (Only for Nellcor SpO <sub>2</sub> )
	10	
	25	
	50	
	100	
<b>HR source</b>	SpO <sub>2</sub>	Take the pulse rate from SpO <sub>2</sub> measurement
	NIBP	Take the pulse rate from blood pressure measurement
	ECG	Take the pulse rate from ECG pressure measurement
	Auto (default)	The monitor automatically switches to a stable heart rate

Alarm type	Hi	Lo	Description
SpO <sub>2</sub>	100 ~ 86	85 ~ 20	When any reading exceeds its limit, the alarm sounds and the reading turns red.
HR (Heart rate)	250 ~ 51	109 ~ 20	

## EXT

Set up the EXT function.

**Save:** Touch “Save” to save the changes. (If no changes, “Save” is in gray and does not function)

**Exit:** Touch “Exit” to exit this page.

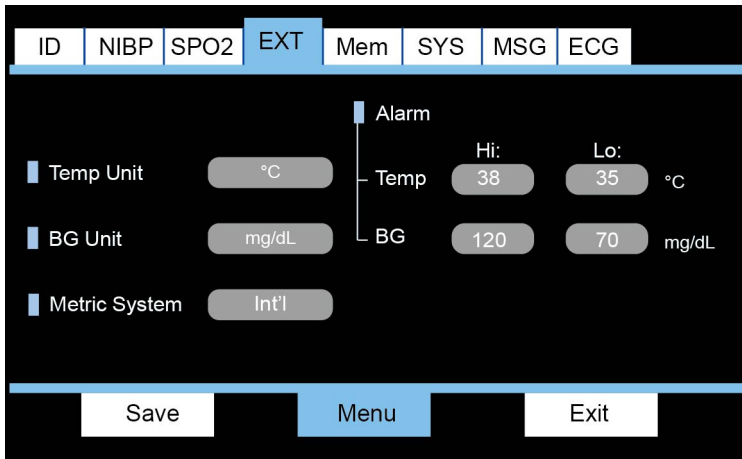

The settings are described as below.

	Unit setting	Description
<b>Temp</b>	°C	Setting for Celsius unit
	°F	Setting for Fahrenheit unit
<b>BG</b> <b>(Blood Glucose)</b>	mg/dL	Setting for mg/dL unit
	mmol/L	Setting for mmol/L unit
<b>Metric System</b>	US	Setting for US unit
	Int'l	Setting for Int'l unit

Alarm Type	Hi	Lo	Description
<b>Temp</b>	43 ~ 35.1 (°C)	37.9 ~ 32 (°C)	When any reading exceeds its limit, the reading turns yellow.
<b>BG</b> <b>(Blood Glucose)</b>	71~101	119~10	When any reading exceeds its limit, the reading turns yellow.

## Mem

The Mem function allows users to retrieve all the readings.

Press SN or ID to enter each data for details.



Delete the selected data.

Which page you are on

Change to other pages

Enter the selected data

ECG file list

Exit this page.

See a data example as below.

2000-01-01 00:17:05		00001/00001	
ID	A123456789	Height	170 cm
Clinic ID	Clinic	Weight	60 Kg
Gender	Female	Age	40
NIBP			
SYS	134 mmHg	Temp	°C
DIA	61 mmHg	BG	mg/dL
MAP	90 mmHg	R.R.	
HR	82 bpm	Pain score	
SPO2			
SPO2	%	Stool	
HR	bpm		

### Note:

- ▶ When storage space is less than 20 records, the TD-2300 will display the reminder information.
- ▶ While the storage is full, it will delete the first 200 records to store the new readings.

## SYS

System setup.

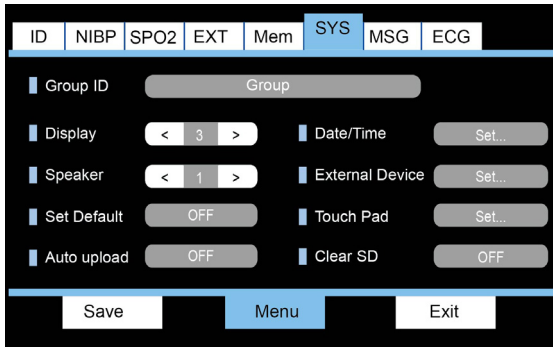

The auto upload selection can be chosen on 5, 10, 20, 30 and 60 minutes.

The settings are described as below.

- **Group ID**

Touch the numbers and letters to key in. Touch "Enter" to input the ID. You can also use a barcode scanner to input the Group ID. Touch "Exit" to exit this page without saving.

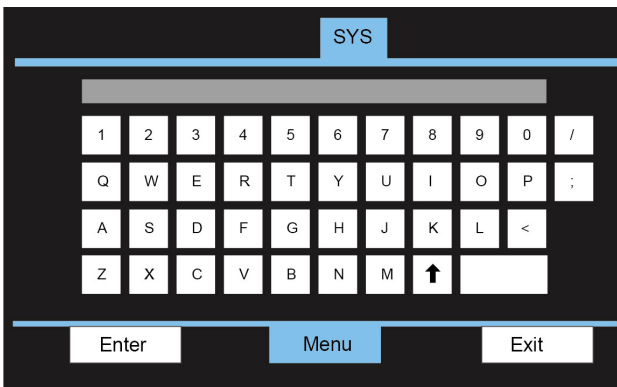

The settings are described as below.

	Setting	Description
<b>Display</b>	1(default)	Touch the icon ">" to increase or "<" to decrease the brightness. 1 is the darkest. 7 is the brightest.
	2	
	3	
	4	
	5	
	6	
	7	
<b>Speaker</b>	1 (default)	Touch the icon ">" to increase or "<" to decrease the volume. 1 is the lowest, 3 is the loudest. (Only for Information tone).
	2	
	3	

- **Date/Time**

Touch "^" and "v" to adjust the Date and Time. Touch "OK" to confirm the setup. Touch "Exit" to exit this page without saving.

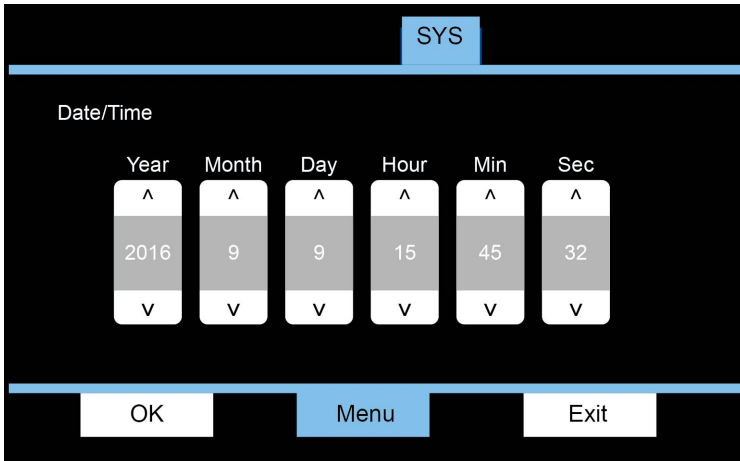

- **Wireless Device**

Pair up BGM (Blood Glucose Meter), IRTM (Infrared Thermometer) or Bluetooth device. Touch “Exit” to leave this page.

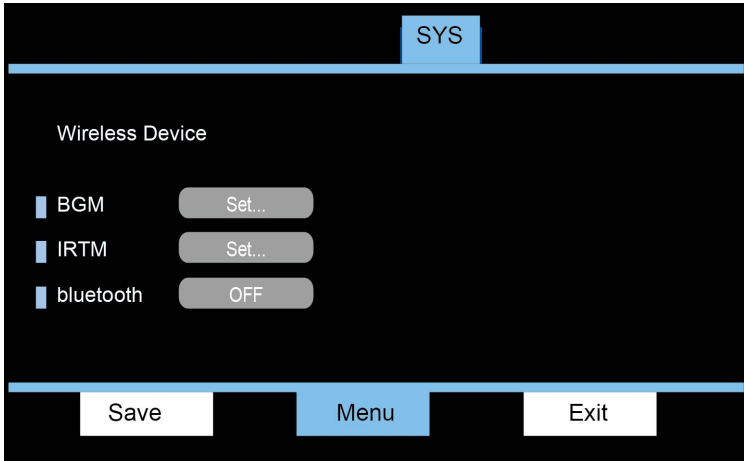

- **Set Default**

Press “OFF” button next to **Set Default** to reset the instrument to factory default settings. A password prompt shows up to avoid incident operations. Enter the password “123” and press “OK”.

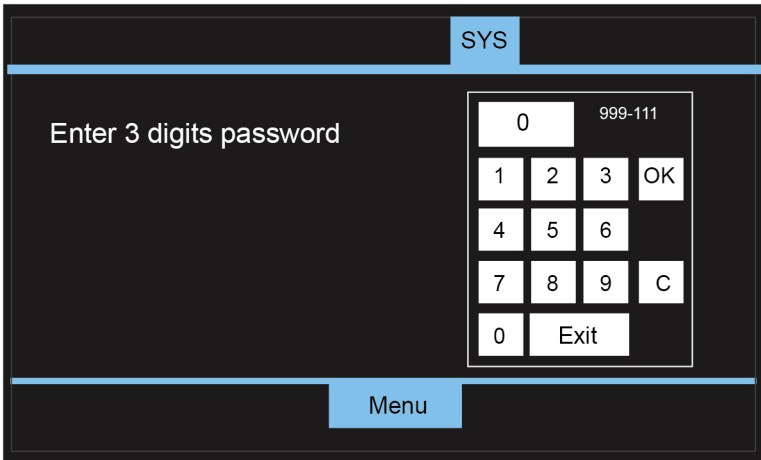

After restoring to the default settings, you have to select the display language before proceeding to the next step.



- **Clear SD**

Press "OFF" button next to **Clear SD** to erase all stored information in the SD memory card. A password prompt shows up to avoid incident operations. Enter the password "123" and press "OK".

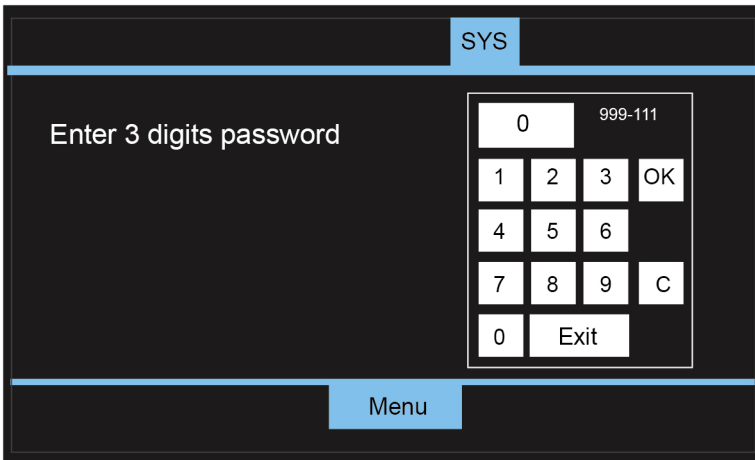

## BGM (Blood Glucose Meter)

Before using the blood glucose meter for the first time, be sure to perform Wireless Device setup below.

1. Enter Menu ► SYS ► Wireless Device

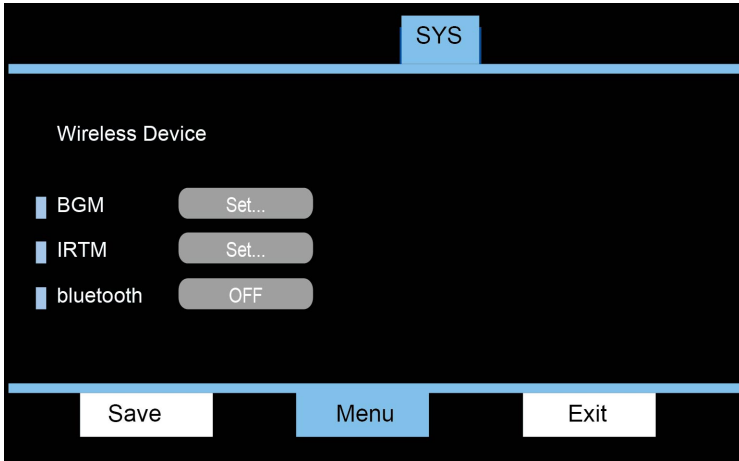

2. Touch "Set" for BGM.

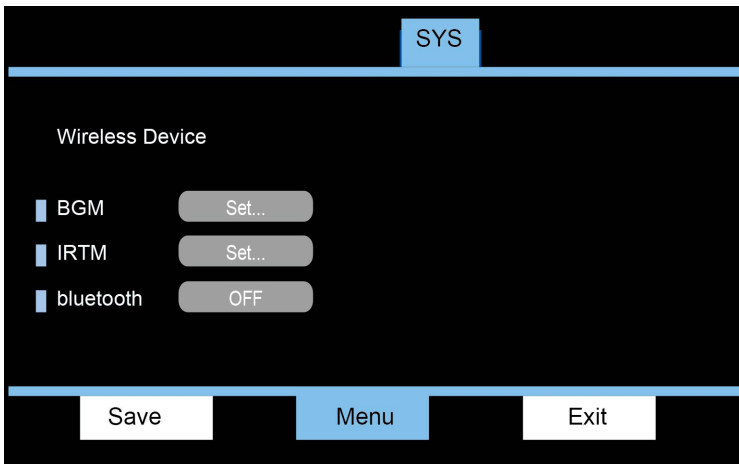

3. "Setting..." is displayed. The monitor is ready for pairing up.

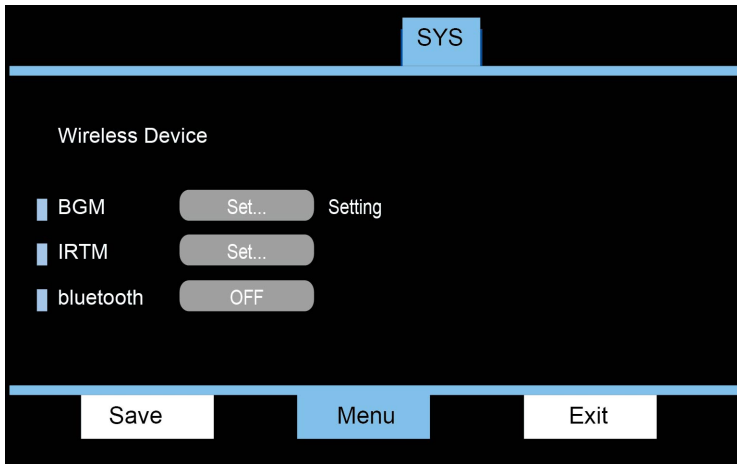

4. Turn on the blood glucose meter.

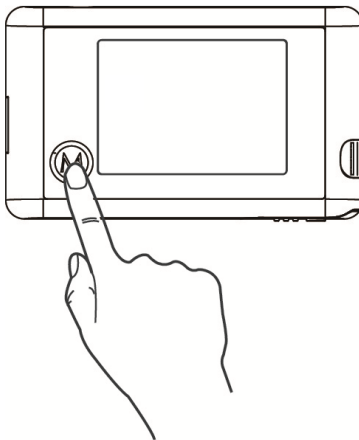

- Put blood glucose meter into the meter holder on the blood glucose meter.

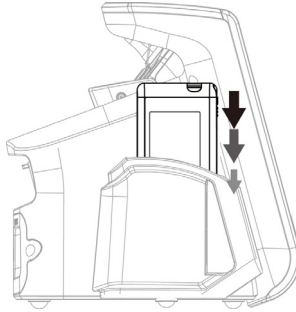

- "OK" is displayed when the meter is identified.

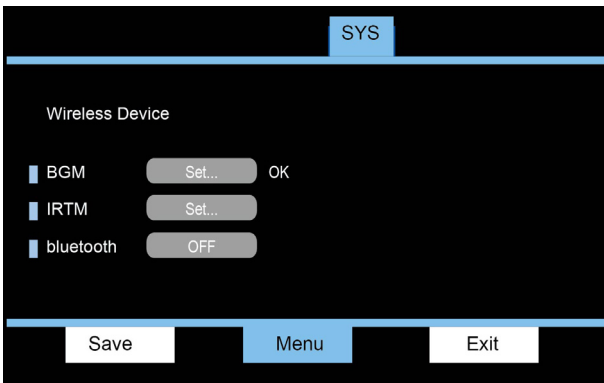

### Infrared Thermometer

- Touch "Set" for IRTM.

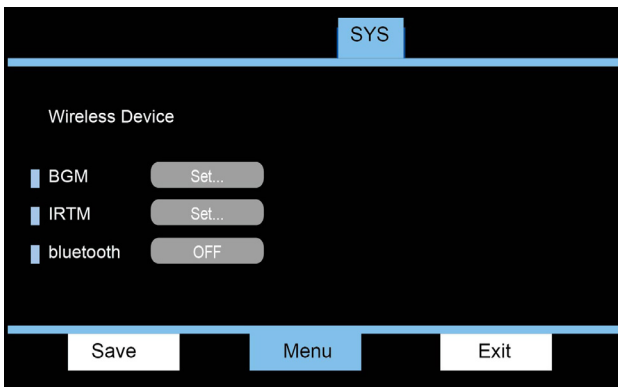

2. "Setting..." is displayed. The monitor is ready for identification.

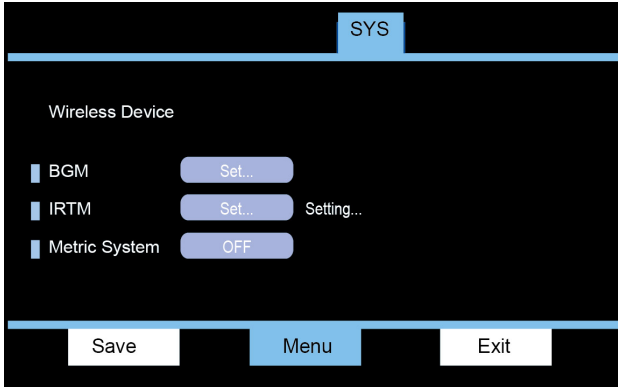

3. Turn on the thermometer.

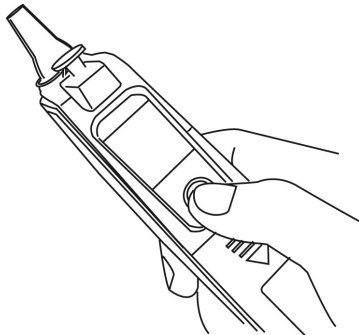

4. Put the IR thermometer into the thermometer holder.

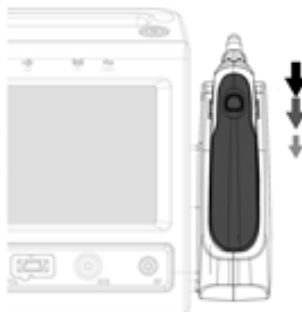

5. "OK" is displayed when the meter is identified.

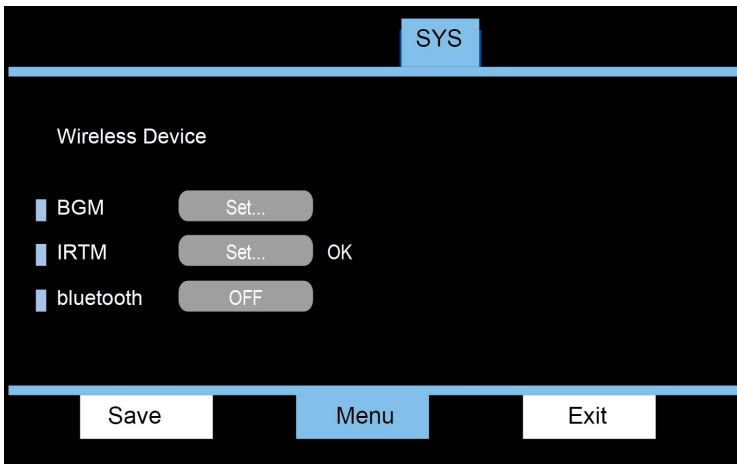

### Bluetooth Settings

PC	Turn on Bluetooth for data transmission in PC mode
Print	Turn on Bluetooth for data transmission in Print mode
OFF	Turn off Bluetooth. (default)

## Wifi Settings

1. Press “Search” button (next to Wifi SSID).

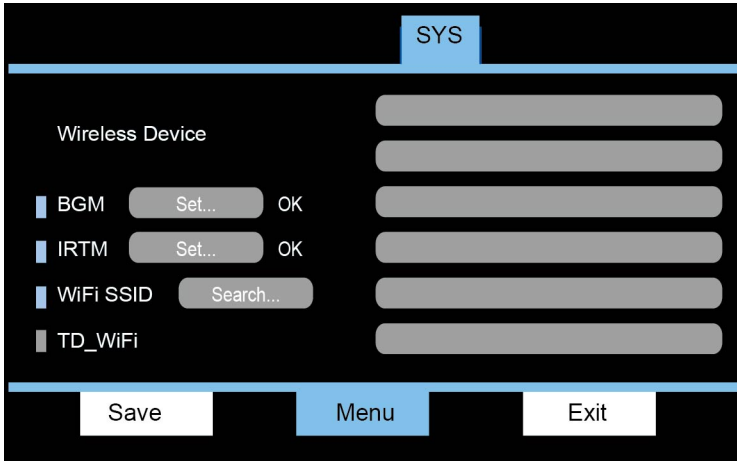

2. While searching for WiFi SSID, the orange RF LED lights up.



3. Displaying the found SSIDs (maximum 6). Press one of them and enter the password.

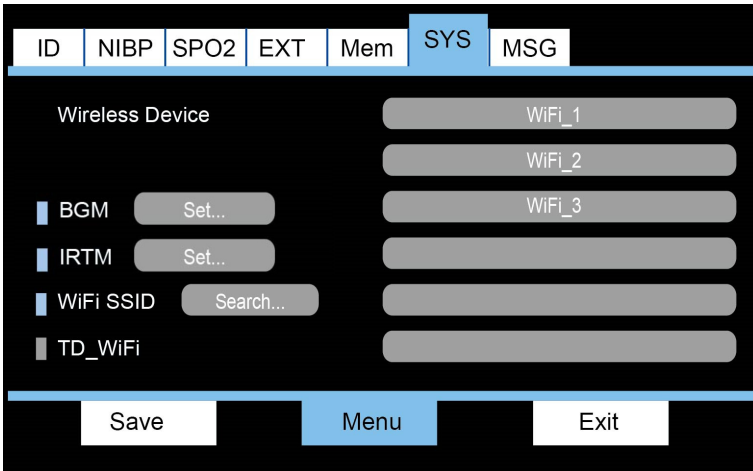

4. Press "Exit". Pairing is now in progress. The SSID will be shaded yellow.

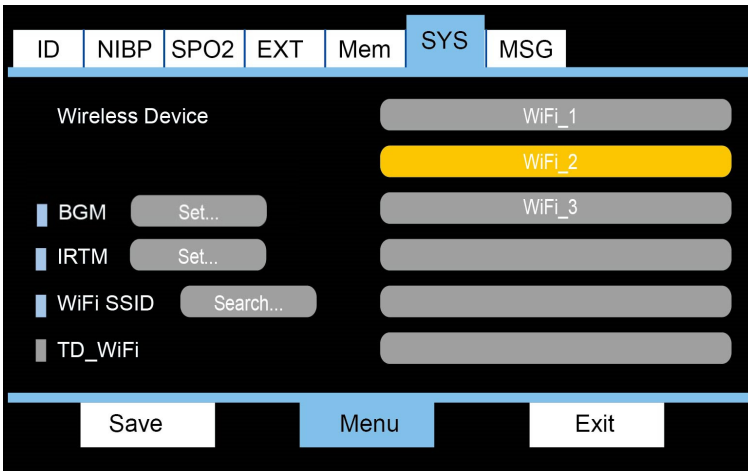

5. If the password is wrong, the SSID will be shaded in red.

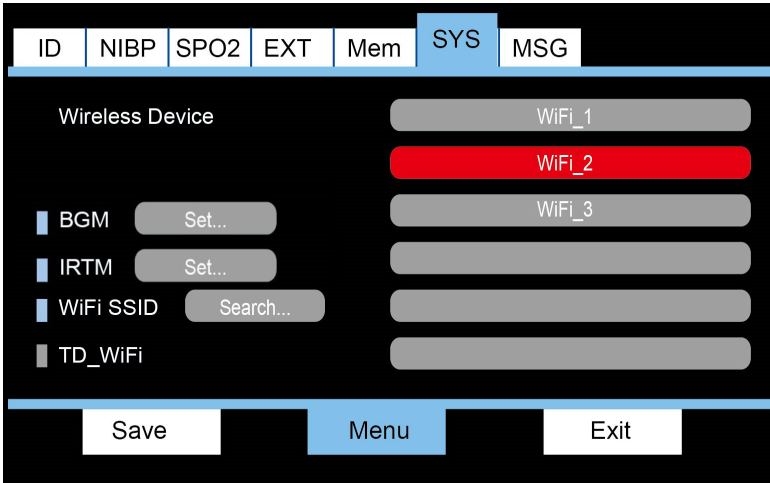

If the password is correct, the SSID will be shaded in green, indicating the pairing is complete.

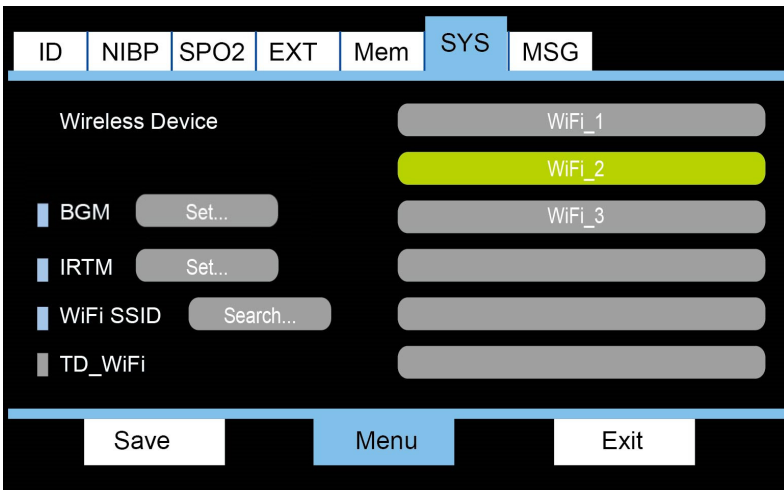

## TD-2300 Setting Tool

1. Use the USB cable to connect the TD-2300 with PC. On the PC, enter the “Td2300 Setting Tool”. The green USB LED lights up.



2. In the “1. Communication Setting” tab, select “HID” and press "Connect" button. Please make sure the USB cable is connected.

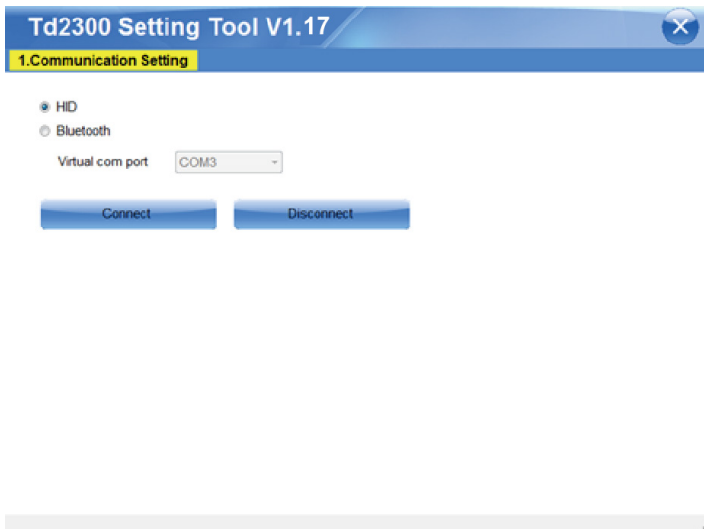

3. After successfully connected, the message will be displayed at the bottom of the screen.

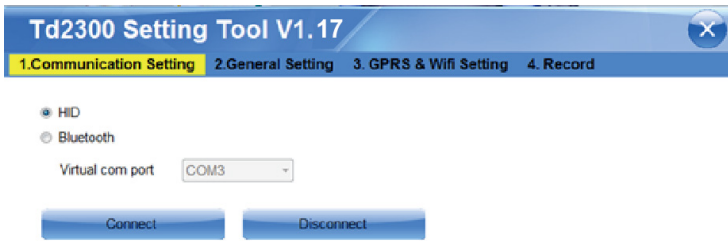

Connect successfully

The display screen on TD-2300 should be as the follows.

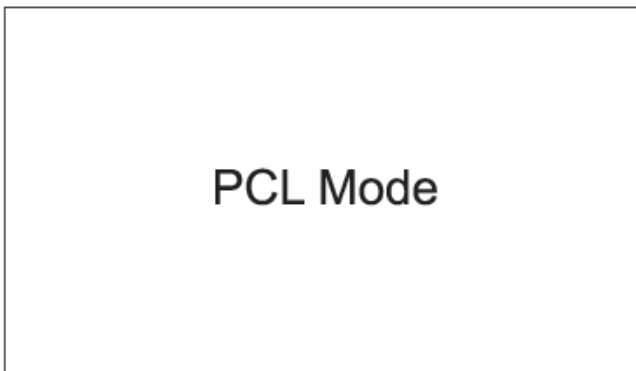

4. In the “3. GPRS & WiFi Setting” tab, select “3.4 Write to Meter”.

**Td2300 Setting Tool V1.17**

1. Communication Setting 2. General Setting **3. GPRS & WiFi Setting** 4. Record

Wifi:

SSID

Wifi MAC

Tele Medical:

Tele medical host name

Tele medical get time path

Tele medical post data path

Tele medical ECG data path

AESKey(Hex)

3.1 Read From Profile  
3.2 Save to Profile  
3.3 Read From Meter  
**3.4 Write to Meter**

Set to meter

Connect successfully

5. Input the required information. For information in the red box, please contact your representative. Press “Set to meter” to complete.

**Td2300 Setting Tool V1.17**

1. Communication Setting 2. General Setting **3. GPRS & WiFi Setting** 4. Record

Wifi:

SSID  Security key

Wifi MAC

Tele Medical:

Tele medical host name

Tele medical get time path

Tele medical post data path

Tele medical ECG data path

AESKey(Hex)

Set to meter

Connect successfully

- Return to “1.Communication Setting” and press “Disconnect”. Remove the USB cable to complete the setting process.

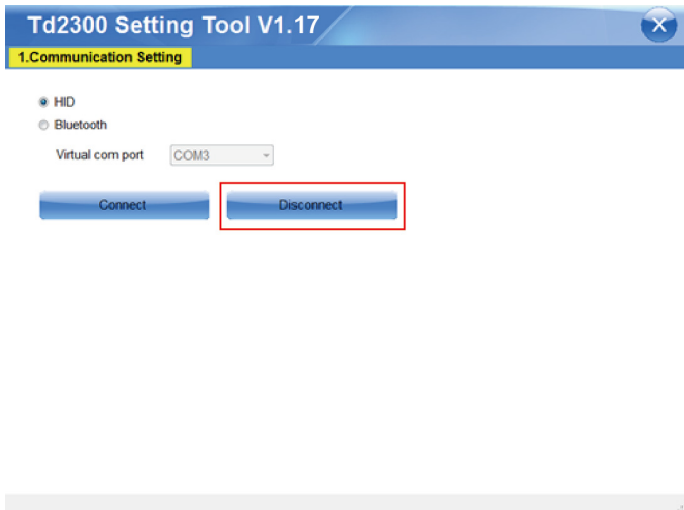

## **Touchpad**

If the monitor is not responding to your touch, please follow the steps below to calibrate the touchpad.

1. Touch “+” on the upper-left corner.

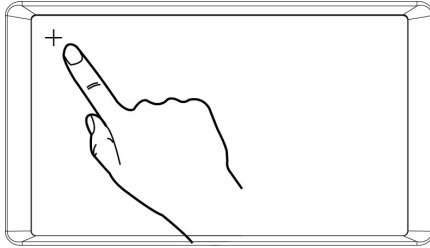

2. Touch “+” on the lower-right corner.

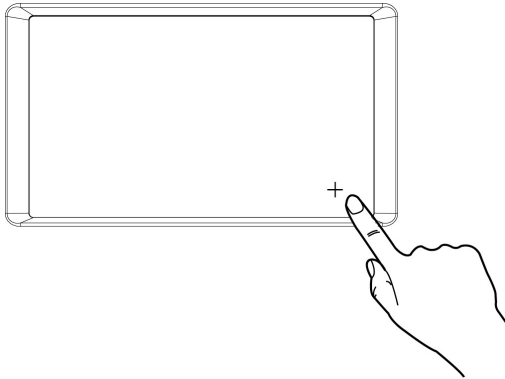

3. Touch “+” on the lower-left corner.

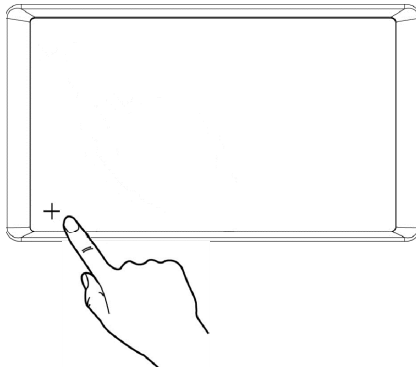

4. Touch “+” on the upper-right corner.

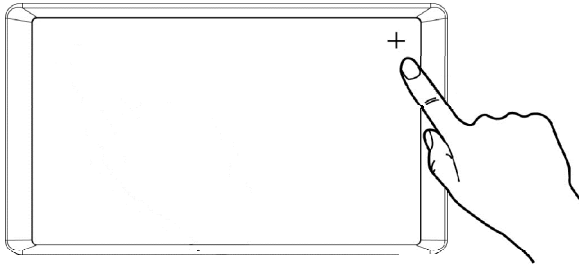

5. Touch the blue area and the calibration is done.

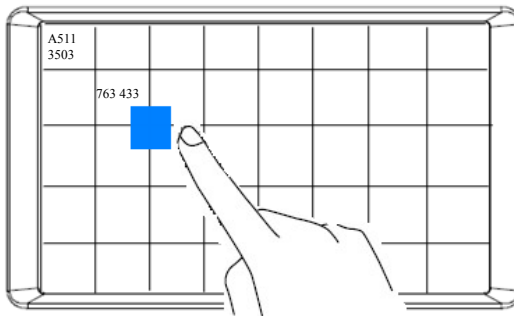

**Note:**

- ▶ In STEP 3, before you touch the blue area ( $200\pm 30, 200\pm 30$ ); you can touch to test the touch screen accuracy. The coordinate of the touched point will be displayed on the upper-left corner of the blue area.
- ▶ When the calibration is done, you will see the monitor main display area as above page 9.
- ▶ After calibration, in case the monitor still does not respond correctly, call your representative.

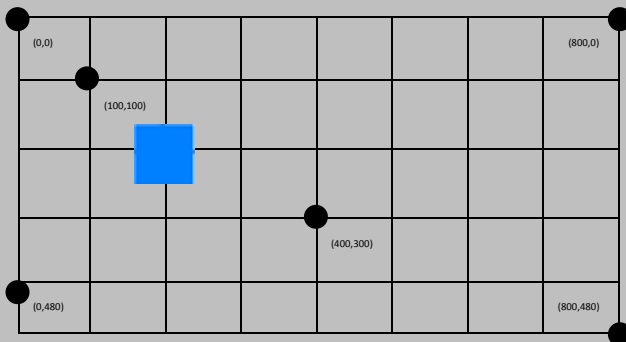

## MSG

You can see the Vital Signs Monitor firmware version, BPM firmware version and SpO<sub>2</sub> firmware version and LOG (history of configuration changes) here.

You can distinguish the different transmission modes from the lower left item on the display (Ex. Bluetooth or Wi-Fi).

ID	NIBP	SPO2	EXT	Mem	SYS	MSG	ECG
Vital Sign Monitor FW Ver				SN: 230011311000003F			
TD2300B: H7V2.2016.05.12				ECG: V02.2014.06.30			
NIBP: V23.2015.09.06		BGM:					
BT:		IRTM:					
				SPO2: V1.0.0.0.2004.05.03			
				Menu		Exit	

ID	NIBP	SPO2	EXT	Mem	SYS	MSG	ECG
Vital Sign Monitor FW Ver				SN: 230011311000003F			
TD2300B: H7V2.2016.05.12				ECG: V02.2014.06.30			
NIBP: V23.2015.09.06		BGM:					
WiFi:		IRTM:					
SSID: TD_WiFi		SPO2: V1.0.0.0.2004.05.03					
				Menu		Exit	

## ECG

Set up the ECG function.

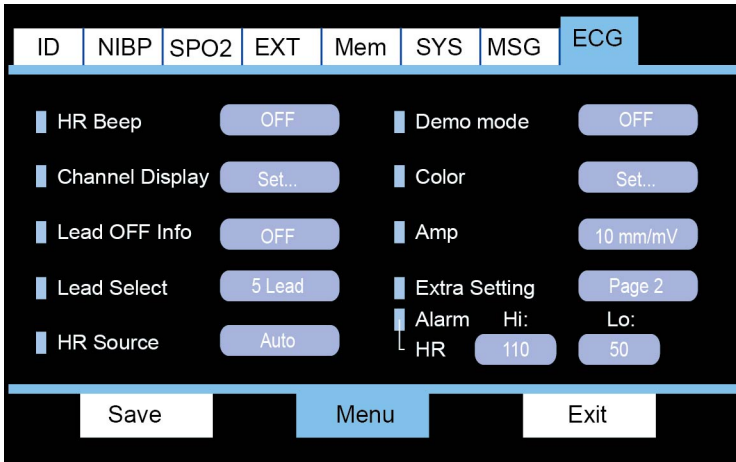

The settings are described as below.

	ECG Setting	Description
HR Beep	On	The monitor beeps as the pulse goes.
	Off (default)	The monitor does not beep along with the pulse.
Lead off Info	Off (default)	Setting for Lead off Alarm
	On	
Lead Select	5 Lead (default)	Setting for Lead wires (When switching between 3 Lead and 5 Lead, please enter "123" as passwords)
	3 Lead	
HR source	SpO <sub>2</sub>	Take the pulse rate from SpO <sub>2</sub> measurement
	NIBP	Take the pulse rate from blood pressure measurement
	ECG	Take the pulse rate from ECG pressure measurement
	Auto (default)	The monitor automatically switches
Demo mode	OFF(default)	Setting view the demo waveform
	ON	
Amp	5mm/mv	Setting vertical scales (Selectable for Print out only)
	10mm/mv(default)	

- **Alarm HR**

Touch the numbers to key in. Touch "OK" to input the weight number. Touch "C" to clear the display area to "0". Touch "Exit" to exit this page without saving.

Input range: 250-51 (If out of this range, touching "OK" does not function)

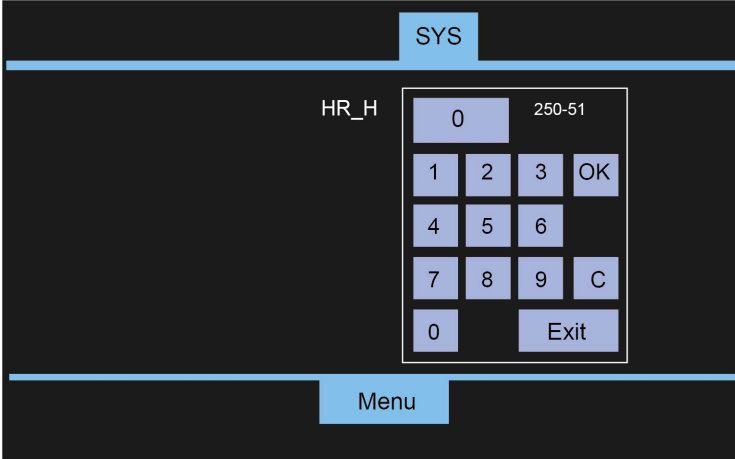

● **Channel Display**

Set up the ECG channel display are described as below. When 5-lead cables option is selected, the device will display two channel outputs.

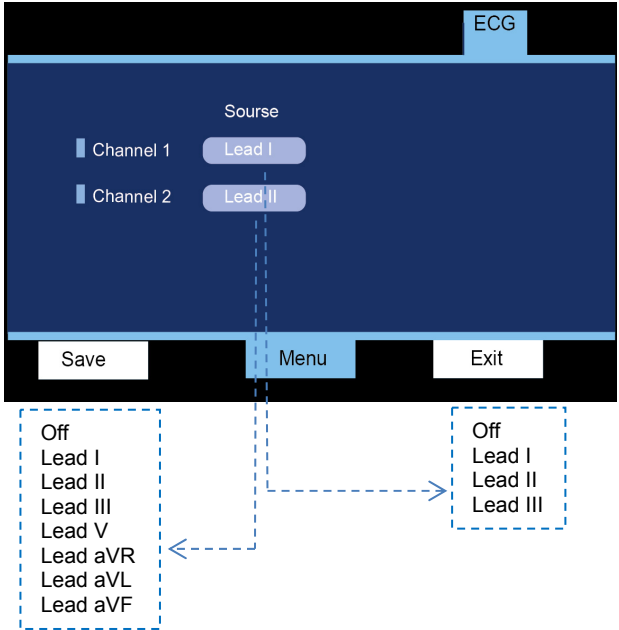

When 3-lead cables option is selected, the device will display one channel output

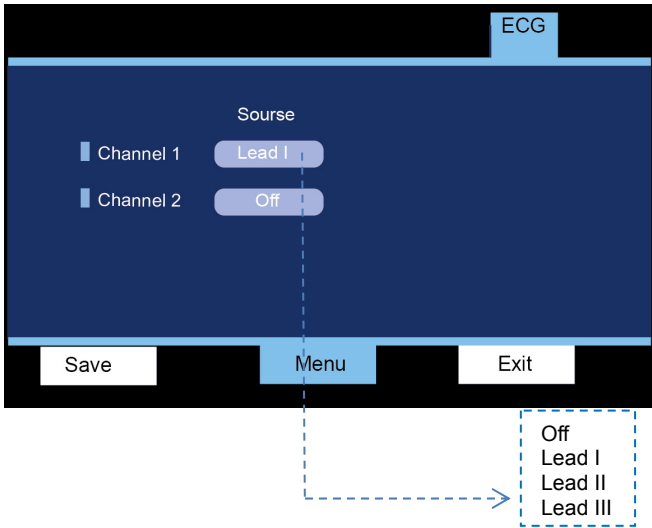

For ECG saving function, the record length for data saving can be selected as 8, 20, 30 and 60 Sec.

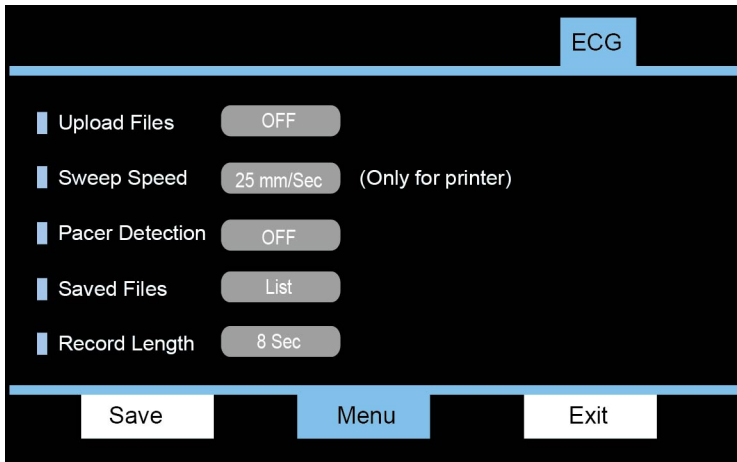

# PERFORM MEASUREMENTS

Before taking measurements, make sure all accessories are firmly plugged into the instrument.

## SpO<sub>2</sub> Measurement

### Taking measurement

1. Clip on patient's finger as below. Please make sure that the patient's finger is inserted to touch the inner bottom of the probe. Once the probe is inserted, the monitor will display "Please check the probe!"
2. Wait for 6 to 10 seconds and the monitor will continuously show the waveforms and the result of SpO<sub>2</sub> and pulse rate until the probe is removed.

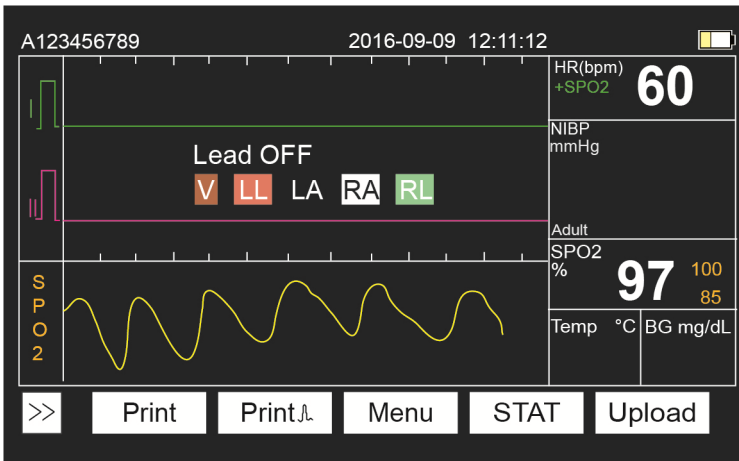
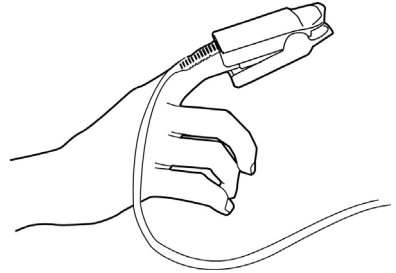

3. Inspect and reposition the sensor frequently (every 2 hours) to prevent skin deterioration.
4. When the sensor is removed, the monitor will display the last SpO<sub>2</sub> reading up to 30 seconds.

**NOTE:**

- ▶ The monitor will display “Probe disconnect!” if the sensor is not connected properly.
- ▶ If the result is out of range, the alert alarm will keep beeping, and the SpO2 result will turn red and start blinking.

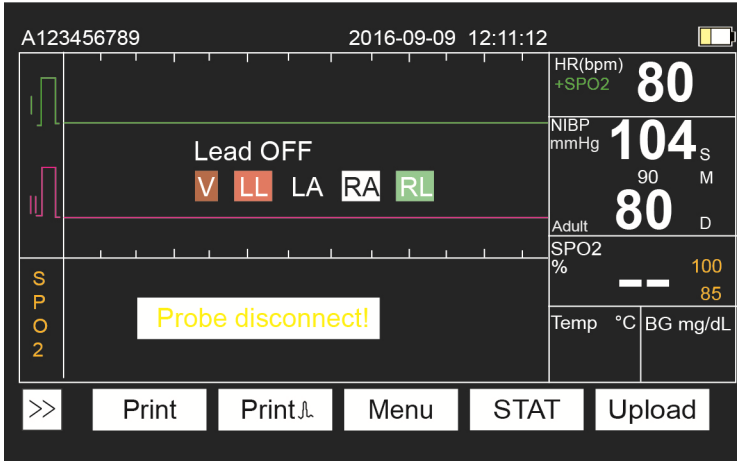

**WARNING:**

- ▶ Do **NOT** use with the instruments which are not specified by the manufacturer. Use of other instruments than we mentioned above may lead to inaccurate results.
- ▶ Skin irritation or ulceration may occur if you apply the sensor to the same location continuously for a long period of time. To prevent this condition, it is recommended moving the sensor application site every 2 hours, or more often if the patient is uncomfortable.

**NOTE:**

- ▶ Misapplication of the SpO2 probes with excessive pressure for prolonged periods can induce pressure injury.
- ▶ A functional tester cannot be used to assess the accuracy of the SpO2 probe or the SpO2 monitor.
- ▶ TD-2300 uses Nellcor OxiMax compatible SpO2 sensor (Ex: TD-8100).
- ▶ TD-2300 uses the SpO2 module of Nellcor.
- ▶ The extension cable for SpO2 sensors, Model number = DOC-10 @Length 3m.

Measurement Performance in Low Perfusion Condition: required the test equipment (PS-III Simulator) the pulse wave is available without failure when the simulation pulse wave amplitude is at 0.03%.

The clinical study includes participants of different ages above 18 years old, all sexes, races, and ethnicities.

The claimed oxygen saturation is supported by coverage of the entire range of clinical research measurement.

# Blood Pressure Measurement

## Before measurement

1. Sit down for at least 10 minutes before measuring.
2. Place your elbow on a flat surface. Relax your hand with the palm facing up.
3. Wrap and tighten the cuff above your elbow. The red line on the edge of the cuff should be approximately 0.8" to 1.2" (2 cm to 3 cm) above your elbow. Align the tube over the main arteries on the inside.

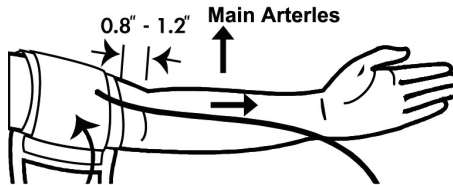

4. Make sure the cuff is about the same height as the location of your heart.

### WARNING:

1. Excessive tightness may cause venous congestion and discoloration of the limb.
2. If the cuff is wrapped too loose or the hose is twisted may cause the inaccurate results.

**NOTE:** The suggested cuff sizes are classified as below:

Population	Cuff Size
Neonate	9-14 cm
	13-21cm
Pediatric	18-26cm
Adult	25-35cm
	33-47cm
	46-66cm

## Taking measurement

Always apply the pressure cuff before turning on the meter.

1. Press "**PUMP**". The cuff will begin to inflate automatically. The LED lights up during the measurement.
2. After the measurement, the monitor displays the systolic pressure, diastolic pressure, mean arterial pressure (MAP) and pulse rate.

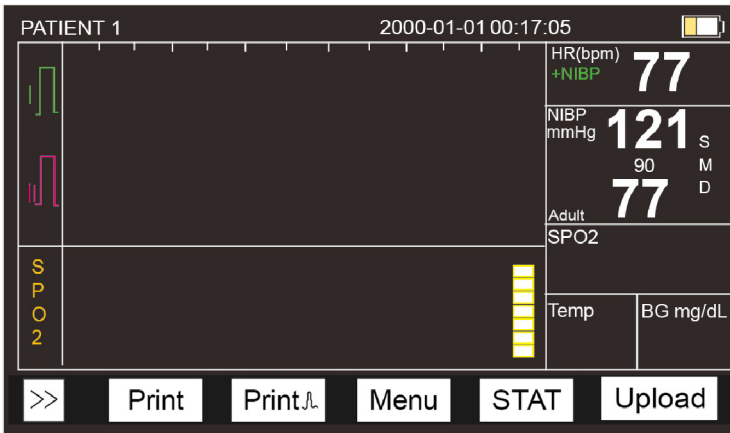

### NOTE:

- ▶ If you press **PUMP** during measurement, the meter will turn off.
- ▶ If the result is out of range, the alert alarm will keep beeping, and the result will turn red.
- ▶ If the meter has detected a big movement or great vibration(s) of the arm during the measurement and cannot produce a value. The meter will then re-pump automatically and take another measurement. Please remain still while taking the measurement.

## STAT

Under STAT mode, the NIBP measurement will be taken consecutively in 5 minutes.

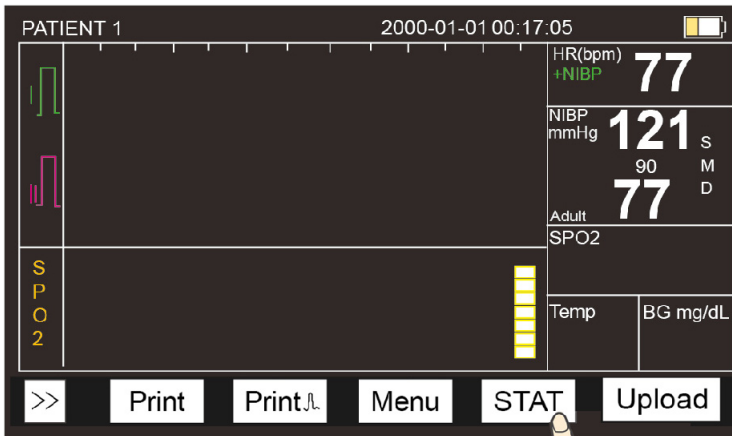

\*The sphygmomanometer was clinically investigated according to the requirements of ISO 81060-2:2013.

# ECG Measurement

## Important Information

Our electrode is color-coded according to American Heart Association (AHA) to eliminate the confusion. The TD-2300 Vital Signs Monitoring system provides 3-lead and 5-lead for user's selection, please follow the guidelines as below.

### 1. Placement of electrodes for the patient without artificial pacemaker

#### A 3-lead electrodes placement:

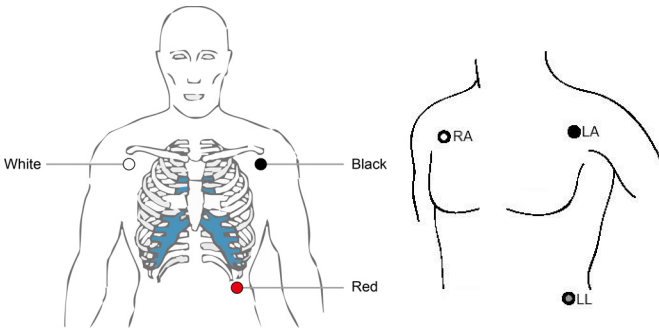

#### B 5-lead electrodes placement:

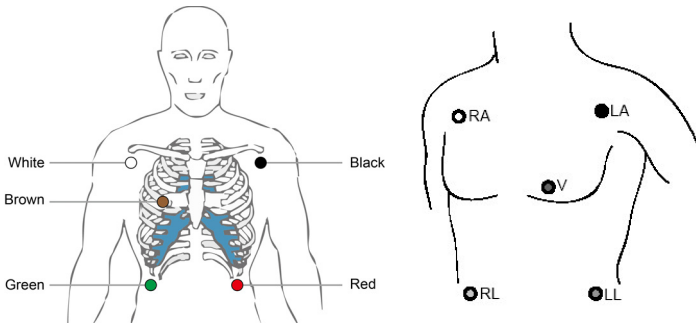

### 2. Placement of electrodes for the patient with artificial pacemaker

An artificial pacemaker is a medical device that uses electrical impulses to regulate the heartbeat.

If the patient is implanted with an artificial pacemaker, the placement of electrodes is different. Please follow the guidelines as below.

### A 3-lead electrodes placement:

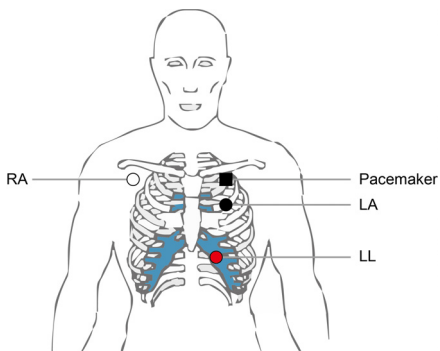

### B 5-lead electrodes placement:

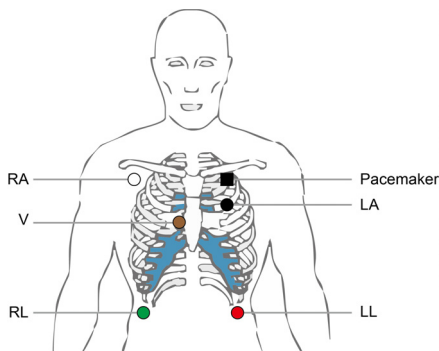

The following table shows IEC (International Electrotechnical Commission) and AHA (American Heart Association) regulations of color-coded electrodes.

System	IEC (Europe)		AHA (U.S.)	
	Electrode identifier	Color	Electrode identifier	Color
Limb	R	Red	RA (right arm)	White
	L	Yellow	LA (left arm)	Black
	F	Green	LL (left leg)	Red
Chest	C1	White/Red	V1	Brown/Red
	C2	White/Yellow	V2	Brown/Yellow
	C3	White/Green	V3	Brown/Green
	C4	White/Brown	V4	Brown/Blue
	C5	White/Black	V5	Brown/Orange
	C6	White/Violet	V6	Brown/Violet
Neutral	N	Black	RL (right leg)	Green

### Before Measurement

1. Shave the hair where the electrodes will be placed.
2. Using cotton moistened with 70% alcohol to clean the area where the electrodes will be placed and let it air dry.
3. Make sure the electrodes are sticky enough to attach on the patient's skin. Please do not reuse the electrodes.

## Taking Measurement

You must enter ECG setting page to confirm your setting every time before taking measurement.

1. Attached the electrodes on the appropriate location according to our guideline.
  2. Wait for few seconds and the monitor will continuously show the ECG waveforms.
- For a 3-lead, the monitor will display only "Lead I" signal.

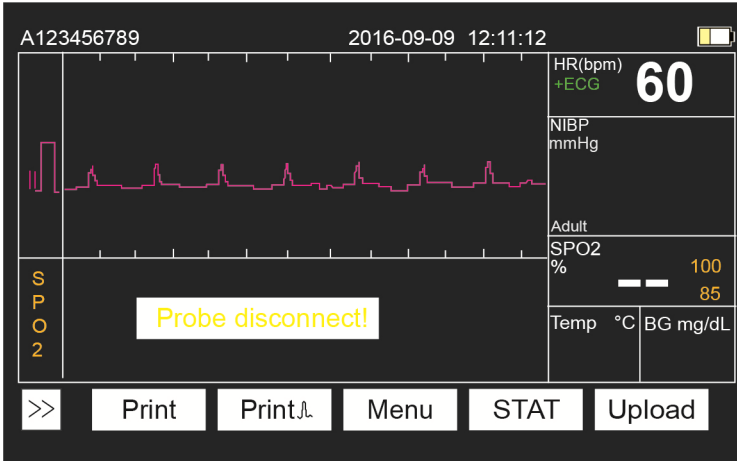

- For a 5-lead, the monitor will display "Lead I" and "Lead II" signal.



Press “>>” once to see “Lead I”, “Lead II”, “Lead III”, “Lead V” signal.

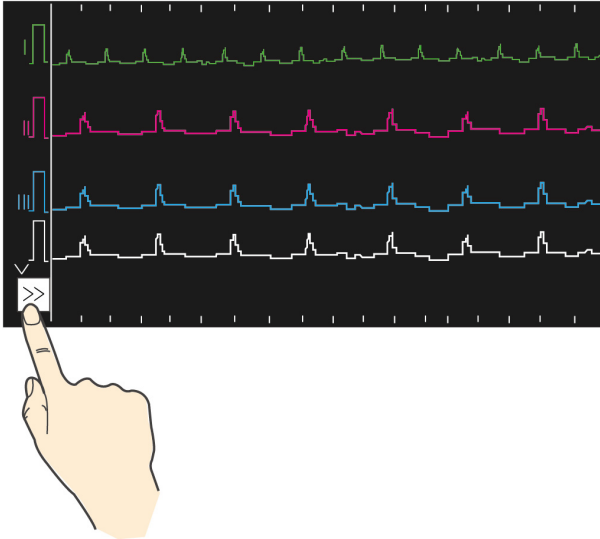

Press “>>” again to see “aVR”, “aVL”, “aVF” signal.

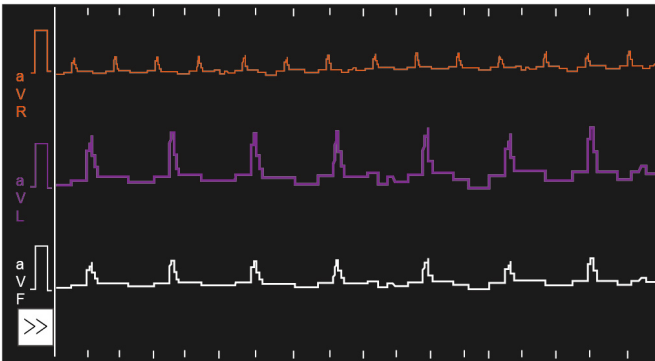

**NOTE:**

- ▶ If you would like to pause and look into details, simply touch the screen to pause for 10 seconds.
- ▶ The monitor will display “Lead-off” and the alert alarm will keep beeping if the electrode is not attached properly.

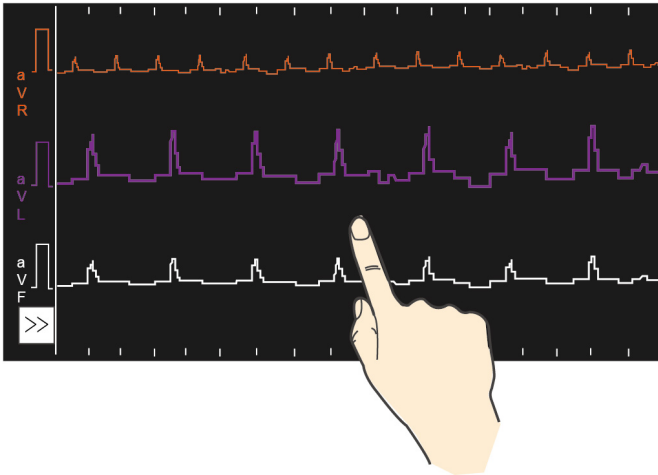

**WARNING:**

- ▶ Skin irritation and the electrode gel dry-out may occur if you apply the electrodes to the same location continuously for a long period of time. It is recommended replacing the electrodes at least every 48 hours.

**NOTE:**

- ▶ The monitor is equipped with 3/5 leads designed for TD-2300. For the purchase of the 3/5 leads, please contact TaiDoc's customer service.
- ▶ The 3/5 leads are compatible with standard disposable ECG electrodes on the market.
- ▶ For daily test, turn on the monitor and "Lead OFF" will displayed on the screen.
- ▶ For 6 months test, connect the ECG simulator. Set the heart rate on ECG simulator to 180bpm, and it will trigger alarm.
- ▶ DO NOT do ECG function testing on the patient used with high-frequency (hf) surgical equipment.
- ▶ 3 Lead = 195-0039800-005 @Length 3m
- ▶ 5 Lead = 195-0039800-003 @Length 3m

## Blood Glucose Measurement

### IMPORTANT SAFETY PRECAUTIONS - READ BEFORE USE

1. Use this device **ONLY** for the intended use described in this manual.
2. Do **NOT** use accessories which are not specified by the manufacturer.
3. Do **NOT** use the device if it is not working properly or if it is damaged.
4. This device does **NOT** serve as a cure for any symptoms or diseases. The data measured is for reference only. Always consult your doctor to have the results interpreted.
5. Before using this device to test blood glucose, read all instructions thoroughly and practice the test. Carry out all the quality control checks as directed.
6. Keep the device and testing equipment away from young children. Small items such as the battery cover, batteries, test strips, lancets and vial caps are choking hazards.
7. Use of this instrument in a dry environment, especially if synthetic materials are present (synthetic clothing, carpets etc.) may cause damaging static discharges that may cause erroneous results.
8. Do **NOT** use this instrument in close proximity to sources of strong electromagnetic radiation, as these may interfere with the accurate operation.
9. Proper maintenance and periodically control solution test are essential to the longevity of your device. If you are concerned about your accuracy of measurement, please contact the local customer service or place of purchase for help.

**KEEP THESE INSTRUCTIONS IN A SAFE PLACE**

## Before You Begin

### Important Information

- Severe dehydration and excessive water loss may cause readings which are lower than actual values.
- Use only fresh whole blood samples to test your blood glucose. Using other substances will lead to incorrect results.
- We do not recommend using this product on severely hypotensive individuals or patients in shock.
- The measurement unit used for indicating the concentration of blood or plasma glucose can either have a weight dimension (mg/dL) or a molarity (mmol/L). The approximate calculation rule for conversion of mg/dL in mmol/L is:

mg/dL	Divided by 18	= mmol/L
mmol/L	Times 18	= mg/dL

For example;

1)  $120 \text{ mg/dL} \div 18 = 6.6 \text{ mmol/L}$

2)  $7.2 \text{ mmol/L} \times 18 = 129 \text{ mg/dL}$  approximately.

### Intended Use

This system is intended for use outside the body (*in vitro* diagnostic use) by healthcare professionals in clinical settings as an aid to monitoring the effectiveness of diabetes control. It is intended to be used for the quantitative measurement of glucose (sugar) in fresh whole blood samples from the finger.

It should not be used for the diagnosis or screening of diabetes.

Professionals may test with capillary, venous, arterial and neonatal blood sample.

## Test Principle

Your system measures the amount of sugar (glucose) in whole blood. The glucose testing is based on the measurement of electrical current generated by the reaction of glucose with the reagent of the strip. The meter measures the current, calculates the blood glucose level, and displays the result. The strength of the current produced by the reaction depends on the amount of glucose in the blood sample.

## Meter Overview

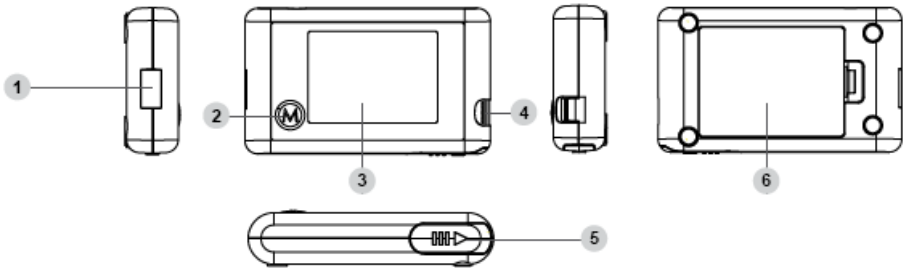

**1. Data Port**

**2. M Button**

Enter the meter memory and silence a reminder alarm.

**3. Display Screen**

**4. Test Strip Slot**

Insert test strip here to turn the meter on for testing.

**5. Test Strip Ejector**

Eject the used strip by pushing up this button.

**6. Battery Compartment**

## Display Screen

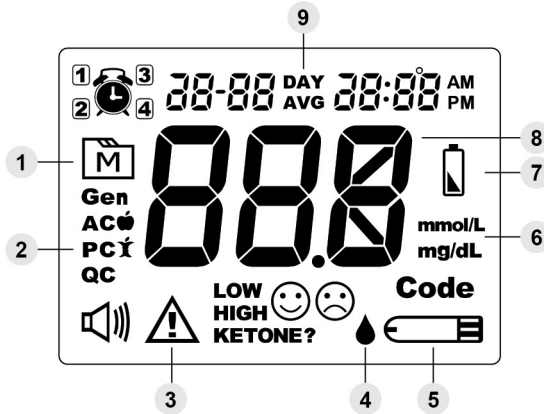

- |                       |                       |
|-----------------------|-----------------------|
| 1. Memory Mode Symbol | 6. Measurement Unit   |
| 2. Measuring Mode     | 7. Low Battery Symbol |
| 3. Error Warning      | 8. Test Result        |
| 4. Blood Drop Symbol  | 9. Day Average        |
| 5. Test Strip Symbol  |                       |

## Test Strip

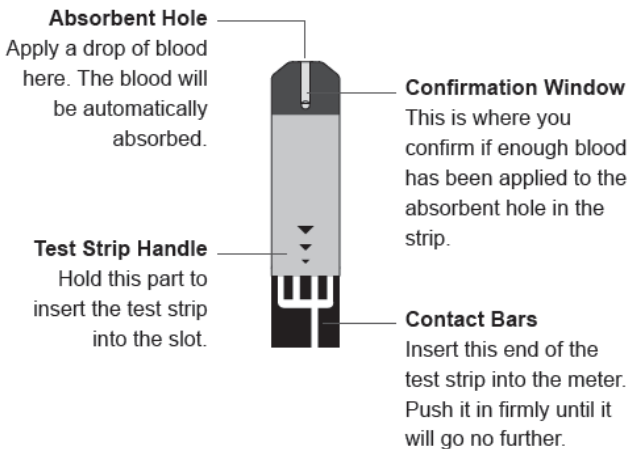



**ATTENTION:**

The front side of test strip should face up when inserting test strip.

Test results might be wrong if the contact bar is not fully inserted into the test slot.

**NOTE:**

- ▶ The TD-2300 blood glucose monitor should only be used with TD-2300 blood glucose test strips. Using other test strips with this meter can produce inaccurate results.

**Setting the Meter**

Before using your meter for the first time or if you change the meter battery, you should check and update these settings. Make sure you complete the steps below and have your desired settings saved.

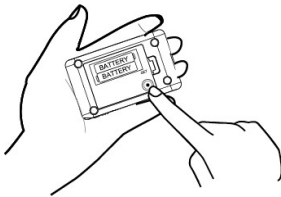

**Entering the Setting Mode**

Start with the meter off (no test strip inserted). Press **SET**.

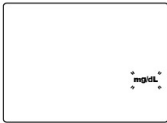

**1. Setting the unit of measurement**

Press **M** to switch between mg/dL and mmol/L. Press **SET**.

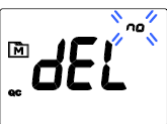
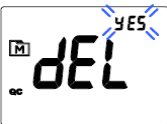

**2. Deleting the QC memory**

With "dEL", "QC" and a flashing "no" on the display, press **M** and select "no" to keep the QC results in memory then press

**SET** to skip.

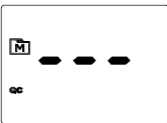

To delete all the QC results, press **M** and select "yes" to delete all the QC memory records.

**Congratulations! You have completed all settings!**

**NOTE:**

- ▶ These parameters can **ONLY be changed** in the setting mode.
- ▶ If the meter is idle for 3 minutes during the setting mode, it will switch off automatically.

## The Four Measuring Modes

The meter provides you with four modes for measuring, General, AC, PC and QC.

MODES	USE WHEN
General(displays as "Gen")	any time of day without regard to time since last meal
AC	no food intake for at least 8 hours
PC	2 hours after a meal
QC	testing with the control solution

You can switch between each mode by:

1. Start with the meter switched off. Insert a test strip to turn on the meter. The screen will display a flashing "M", " " and Gen.

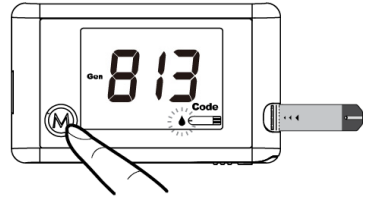

2. Press **M** to switch between General, AC, PC and QC mode.

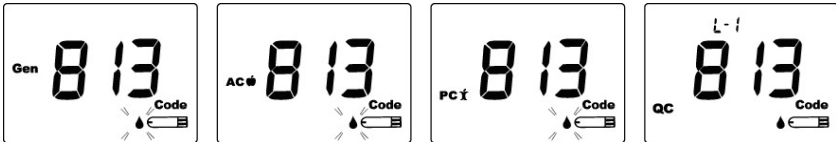

## Before Testing

### Checking the Code Number

You need to make sure that the code number displayed on the meter matches the number on the test strip vial before you proceed. If it matches, you can proceed with your test. If the codes do not match, please stop testing and contact Customer Service for help.

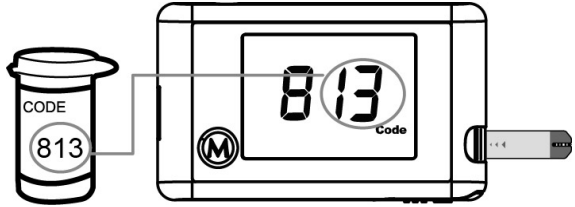

#### NOTE:

- ▶ The code number on the display is only for your reference, it may not be actual code for this meter.

#### Warning:

- ▶ It is important to make sure that the LCD displayed code is the same as the code on the test strip vial before testing. Failure to do so will get inaccurate results.
- ▶ If the LCD displayed code is not the same as the code on the test strip vial, and the code number cannot be updated, please contact Customer Service for assistance.

### Control Solution Testing

Our Control Solution contains a known amount of glucose that reacts with test strips and is used to ensure your meter and test strips are working together correctly.

#### Do a control solution test when:



- you first receive the meter,
- at least once a week to routinely check the meter and test strips,
- you begin using a new vial of test strips,
- you suspect the meter or test strips are not working properly,

- your blood glucose test results are not consistent with how you feel, or if you think the results are not accurate,
- practicing the testing process, or
- you have dropped or think you may have damaged the meter.

Test strips, control solutions, or sterile lancets may not be included in the kit (please check the contents on your product box). They can be purchased separately. Please make sure you have those items needed for a blood glucose test beforehand.

### Performing a Control Solution Test

#### 1. Insert the test strip to turn on the meter

Insert the test strip into the meter. Wait for the meter to display “CHK” and “” and “.

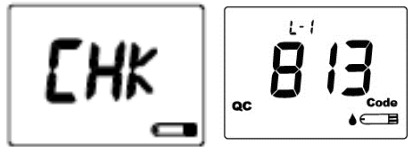

#### 2. Press M to mark this test as a control solution test

With “QC” displayed, the meter will store your test result in memory under “QC”. If you press **M** again, the “QC” will disappear and this test is no longer a control solution test.



#### WARNING:

- ▶ When doing the control solution test, you have to mark it so that the test result will NOT mix with the blood glucose TEST RESULTS stored in the memory. Failure to do so will mix up the blood glucose test results with the control solution test results in memory.

#### 3. Apply Control Solution

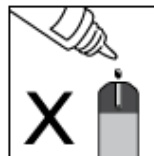

Shake the control solution vial thoroughly before use. Squeeze out the first drop and wipe it off, then squeeze out another drop and place it on the tip of the vial cap.

Hold the meter to move the absorbent hole of the test strip to touch the drop. Once the confirmation window fills completely, the meter will begin counting down.

**NOTE:**

- ▶ To avoid contaminating the control solution, do not directly apply control solution onto a strip.

**4. Read and Compare the Result**

After counting down to 0, the control solution test result will appear on the display. Compare this result with the range printed on the test strip vial and it should fall within this range. If

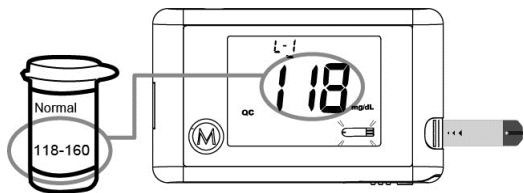

not, the meter will ask you to repeat the control solution test until it falls within this range and then you can go to next level.

(118 mg/dL = 6.5 mmol/L; 118-160 mg/dL = 6.5-8.8 mmol/L)

**Out-of-range results**

If you continue to have test results fall outside the range printed on the test strip vial, the meter and strips may not be working properly. Do NOT test your blood. Contact the local customer service or place of purchase for help.

**NOTE:**

- ▶ The control solution range printed on the test strip vial is for control solution use only. It is not a recommended range for your blood glucose level.
- ▶ See the **MAINTENANCE** section for important information about your control solutions.

## Testing With Blood Sample

### Warning:

To reduce the chance of infection:

- ▶ Always wear gloves and follow your facility's biohazard control policy and procedures when performing tests involving patient blood samples.
- ▶ Wear a new pair of clean gloves before testing each patient. Change gloves between patients.
- ▶ Never share a safety lancet.
- ▶ Only auto-disabling, single use safety lancet may be used with this device.
- ▶ Avoid getting hand lotion, oils, dirt, or debris in or on the safety lancet.

We recommend you perform disinfection procedures between each patient. Please refer to the section Cleaning and Disinfection Procedures for complete instructions. After disinfection, used gloves should be removed and hands washed before proceeding to the next patient.

### Preparing the Puncture Site

Stimulating blood perfusion by rubbing the puncture site before blood extraction has a significant influence on the glucose value obtained.

Blood from a site that has not been rubbed exhibits a measurably different glucose concentration than blood from the finger. When the puncture site was rubbed prior to blood extraction, the difference was significantly reduced.

**Please follow the suggestions below before obtaining a drop of blood:**

- **Wash and dry your hands before starting. Put on a new pair of gloves.**
- Select the puncture site at fingertips.
- Rub the puncture site for about 20 seconds before penetration.
- Clean the puncture site using cotton moistened with 70% alcohol and **let it air dry.**

## Fingertip testing

Press the safety lancet firmly against the lower side of patient's fingertip.

### NOTE:

- ▶ Choose a different spot each time you test. Repeated punctures at the same spot may cause soreness and calluses.
- ▶ It is recommended that you discard the first drop of blood as it might contain tissue fluid, which may affect the test result.

## Performing a Blood Glucose Test

1. **Insert the test strip to turn on the meter**

Wait for the meter to display "CHK" and "🔴".

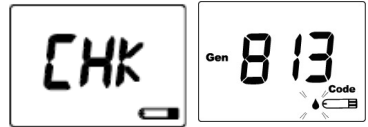

2. **Select the appropriate measuring mode by pressing M.**

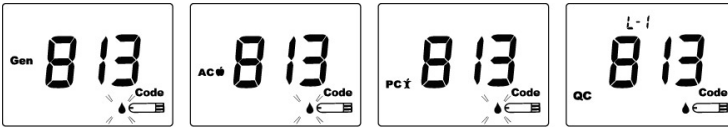

3. **Obtaining a blood sample**

Use the safety lancet to puncture the desired site. Wipe off the first appeared drop of blood with a clean cotton swab. The size of the drop should be at least as big as • (actual size), which is 1.0 microliter ( $\mu\text{L}$ ) of volume. Gently squeeze the punctured area to obtain another drop of blood. Be careful **NOT** to smear the blood sample.

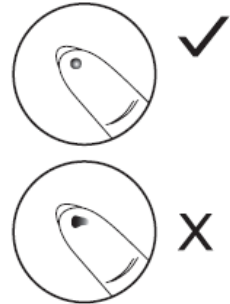

4. **Apply the sample**

Gently apply the drop of blood to the absorbent hole of the test strip at a titled angle. Confirmation window should be completely filled if enough blood sample has been applied. Do **NOT** remove your finger until you hear a beep sound.

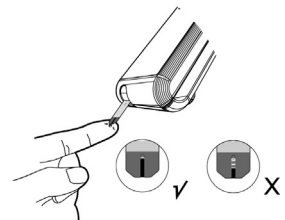

**NOTE:**

- ▶ Do not press the punctured site against the test strip or try to smear the blood.
- ▶ If you do not apply a blood sample to the test strip within 3 minutes, the meter will automatically turn off. You must remove and reinsert the test strip to start a new test.
- ▶ The confirmation window should be filled with blood before the meter begins to count down.  
**NEVER** try to add more blood to the test strip after the drop of blood has moved away. **Discard the used test strip and retest with a new one.**
- ▶ If you have trouble filling the confirmation window, please contact your healthcare professional or the local customer service for assistance.

**5. Read Your Result**

The result of the blood glucose test will appear after the meter counts down to 0. The blood glucose result will be stored in the meter memory and transmit to the vital signs monitoring system automatically. (100 mg/dL = 5.5 mmol/L)

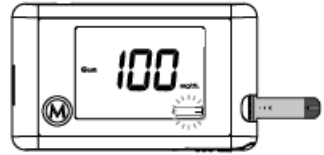

**6. Eject the used test strip**

Eject the test strip by pushing the eject button on the side. Use a sharp bin to dispose of used test strips. The meter will switch itself off automatically.

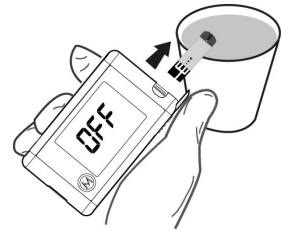

**Always follow the instructions in the safety lancet.**

**WARNING:**

- ▶ The used lancet and test strip may be biohazardous. Please discard them carefully according to your local regulations.

## 7. Data transmission

After removing the test strip, the flashing “Con” will appear along with the blood glucose test result, indicating that you need to put the meter into the holder in order to transmit the result.

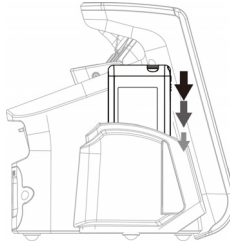



## Maintenance

### Battery

Your meter comes with two 1.5V AAA size alkaline batteries.

#### Low Battery Signal

The meter will display one of the messages below to alert you when the meter power is getting low.

1. The “” symbol appears along with display messages: The meter is functional and the result remains accurate, but it is time to change the batteries.
2. The “” symbol appears with **E-b, Error and low**: The power is not enough to do a test. Please change the batteries immediately.

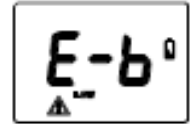

#### Replacing the Battery

To replace the batteries, make sure that the meter is turned off.

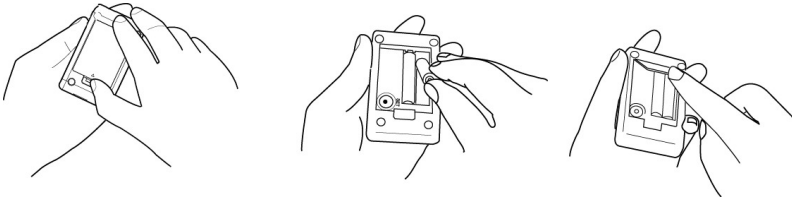

1. Press the edge of the battery cover and lift it up to remove.
2. Remove the old batteries and replace with two 1.5V AAA size alkaline batteries.
3. Close the battery cover. If the batteries are inserted correctly, you will hear a "beep" afterwards.

#### NOTE:

- ▶ Replacing the battery does not affect the test results stored in the memory.
- ▶ As with all small batteries, these batteries should be kept away from children. If swallowed, promptly seek medical assistance.
- ▶ Batteries might leak chemicals if unused for a long time. Remove the batteries if you are not going to use the device for an extended period (i.e., 3 months or more).
- ▶ Properly dispose of the batteries according to your local environmental regulations.

## Caring for Your Meter

To avoid the meter and test strips attracting dirt, dust or other contaminants, please wash hands thoroughly with soap and water before and after use.

### When to clean and disinfect the meter

All surface of meter if visibly soiled must be physically cleaned to remove soil. Disinfect the meter between each patient to prevent infection.

### How to clean and disinfect the meter

The meter must be cleaned prior to the disinfection. Use one disinfecting wipe to clean exposed surfaces of the meter thoroughly and remove any visible dirt, blood or any other body fluid with the wipe. Use a second wipe to disinfect the meter by following the disinfecting procedure below. Do NOT use organic solvents to clean the meter.

We recommend for meter cleaning and disinfection you should use the disinfecting wipe/towelette from below.

✓ Micro-Kill™ (Micro-Kill Plus™) by Medline (EPA Reg. No. 59894-10-37549)

To obtain disinfecting wipes and other information, please contact Medline at 1-800-MEDLINE (1-800-633-5463) or visit [www.medline.com](http://www.medline.com). You can also purchase at [www.amazon.com](http://www.amazon.com).

### Disinfecting Procedures

1. Put on non-sterile gloves.
2. Take out one disinfecting wipe from the package and squeeze out any excess liquid in order to prevent damage to the meter.
3. Wipe all meter's exterior surface display and buttons. Hold the meter with the test strip slot pointing down and wipe the area around the test slot but be careful not to allow excess liquid to get inside. Keep meter wet with disinfection solution contained in the wipe for a minimum of 2 minutes for Micro-Kill+™ wipes. Follow the instructions on the package label of disinfecting wipe. Remove the wipe. Allow the meter surface to dry completely.

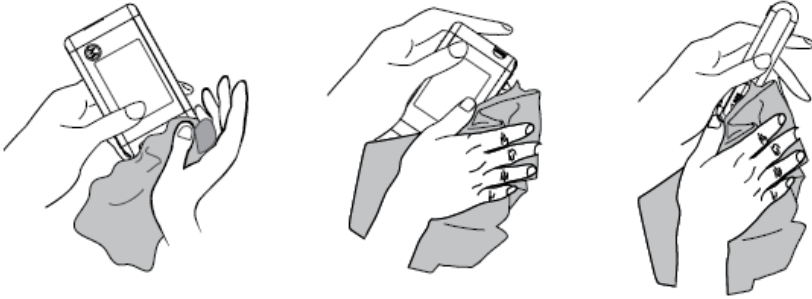

4. Discard the used wipes and never reuse them.
5. Remove and discard gloves in appropriate receptacles and wash hands.

After disinfection, remove the used gloves and wash hands before proceeding to the next patient.

Each cleaning and disinfection cycle includes a pre-cleaning step with one wipe and a disinfection step with a second wipe.

This device has been validated to withstand up to 10,000 cleaning and disinfection cycles using the recommended disinfecting wipe/towelette. The tested number of cycles is estimated by 9 cleaning and disinfection cycles per day over 3 years, the expected life of the device. The meter should be replaced after the validated number of cleaning and disinfection cycles or the warranty period, whichever comes first. Improper system cleaning and disinfection may result in meter malfunction. Stop using the meter if you see any signs of deterioration, for example, LCD display cracks or becomes cloudy, buttons no longer function, or outer casing cracks. If you have any question. Please contact customer service for a replacement meter if any of the signs of deterioration are noticed.

**NOTE:**

- Do NOT clean and disinfect the meter while performing tests.
- Please follow the instructions on the package label of Micro-Kill+™ disinfecting wipes for safe use of the wipes
- Do NOT allow cleaning and disinfecting solution to get in the test slot, battery compartment, or strip-ejection button.

- If you do get moisture in the test strip slot, wipe it away with a tissue.
- Always dry the meter thoroughly before using it
- Do not spray the meter directly with cleaning solutions especially those containing water (i.e. soapy water), as this could cause the solution to enter the case inside and damage the electronic components or circuitry

For more information on the risk of blood-borne pathogen transmission from blood glucose meter and safety lancet, please refer to:

*"FDA Public Health Notification: Use of Fingertick Devices on More than One Person Poses Risk for Transmitting Bloodborne Pathogens: Initial Communication" (2010)*

<http://wayback.archive-it.org/7993/201701111013014/http://www.fda.gov/MedicalDevices/Safety/AlertsandNotices/ucm224025.htm>

*"CDC Clinical Reminder: Use of Fingertick Devices on More than One Person Poses Risk for Transmitting Bloodborne Pathogens" (2010)* <http://www.cdc.gov/injectionsafety/Fingertick-DevicesBGM.html>

### **Meter Storage**

- Storage condition: -20°C to 60°C (-4°F to 140°F), 10% to 95% relative humidity.
- Always store or transport the meter in its original storage case.
- Avoid dropping and strong impact.
- Avoid direct sunlight and high humidity.

### **Meter Disposal**

The used meter should be treated as contaminated that may carry a risk of infection during measurement. The batteries in this used meter should be removed and the meter should be disposed in accordance with local regulations.

The meter falls outside the scope of the European Directive 2002/96/EC-Directive on waste electrical and electronic equipment (WEEE).

## Caring for Your Test Strips

- Storage conditions: 2°C to 30°C (35.6°F to 89°F), below 10% to 85% relative humidity. Do **NOT** freeze.
- Store your test strips in their original vial only. Do not transfer to another container.
- Store test strip packages in a cool dry place. Keep away from direct sunlight and heat.
- After removing a test strip from the vial, immediately close the vial cap tightly.
- Touch the test strip with clean and dry hands.
- Use each test strip immediately after removing it from the vial.
- Write the opening date on the vial label when you first opened it. Discard remaining test strips after 6 months.
- Do not use test strips beyond the expiration date. This may cause inaccurate results.
- Do not bend, cut, or alter a test strip in any way.
- Keep the strip vial away from children since the cap and the test strip may be a choking hazard. If swallowed, promptly see a doctor for help.

For further information, please refer to the test strip package insert.

## Important Control Solution Information

- Use only our control solutions with your meter.
- Do not use the control solution beyond the expiration date or 3 months after first opening. Write the opening date on the control solution vial and discard the remaining solution after 3 months.
- It is recommended that the control solution test be done at room temperature 20°C to 25°C (68°F to 77°F). Make sure your control solution, meter, and test strips are at this specified temperature range before testing.
- Shake the vial before use, discard the first drop of control solution, and wipe off the dispenser tip to ensure a pure sample and an accurate result.
- Store the control solution tightly closed at temperatures between 2°C to 30°C (35.6°F to 86°F). Do **NOT** freeze.

## System Troubleshooting

If you follow the recommended action but the problem persists, or error messages other than the ones below appear, please call your local customer service. Do not attempt to repair yourself and never try to disassemble the meter under any circumstances.

### Result Readings

MESSAGE	WHAT IT MEANS
Lo	< 10 mg/dL (0.5 mmol/L).
Hi	> 600 mg/dL (33.3 mmol/L).

### Troubleshooting

1. If the meter does not display a message after inserting a test strip:

POSSIBLE CAUSE	WHAT TO DO
Batteries exhausted.	Replace the batteries.
Test strip inserted upside down or incompletely.	Insert the test strip with contact bars end first and facing up.
Defective meter or test strips.	Please contact customer service.

2. If the test does not start after applying the sample:

POSSIBLE CAUSE	WHAT TO DO
Insufficient blood sample.	Repeat the test using a new test strip with larger volume of blood sample.
Defective test strip.	Repeat the test with a new test strip.
Sample applied after automatic switch-off (3 minutes after last user action).	Repeat the test with a new test strip. Apply sample only when flashing "🔥" appears on the display.
Defective meter.	Please contact customer service.

3. If the control solution testing result is out of range.

POSSIBLE CAUSE	WHAT TO DO
Error in performing the test.	Read instructions thoroughly and repeat the test again.
Control solution vial was poorly shaken.	Shake the control solution vigorously and repeat the test again.
Expired or contaminated control solution.	Check the expiration date of the control solution.
Control solution that is too warm or too cold.	Control solution, meter, and test strips should be at room temperature 20°C to 25°C (68°F to 77°F) before testing.
Defective test strip.	Repeat the test with a new test strip.
Meter malfunction.	Please contact customer service.

### Detailed Information

The Blood glucose monitoring plays an important role in diabetes control. A long-term study showed that maintaining blood glucose levels close to normal can reduce the risk of diabetes complications by up to 60%.<sup>\*1</sup>

Time of day	Normal plasma glucose range for people <b>without</b> diabetes (mg/dL)
Fasting <sup>*2</sup> and before meal	< 100 mg/dL (5.6 mmol/L)
2 hours after meals	< 140 mg/dL (7.8 mmol/L)

\*1: American Diabetes Association. Classification and Diagnosis of Diabetes: Standards of Medical Care in Diabetes—2020 Jan; 43(Supplement 1): S14-S31. <https://doi.org/10.2337/dc20-S002>

\*2: Fasting is defined as no caloric intake for at least 8 hours.

# Temperature Measurement

## Before You Begin

### Important Safety Instructions - Read Before Use

The following basic safety precautions should always be taken.

1. Close supervision is necessary when the thermometer is used by, on, or near children, handicapped persons or invalids.
2. Use the thermometer only for the intended use described in this manual.
3. Do not use the thermometer if it is not working properly, or if it has suffered any damage.
4. Do not use accessories which are not supplied or recommended by the manufacturer.

**KEEP THESE INSTRUCTIONS IN A SAFE PLACE**

### Cautions and Warnings

- As with any thermometer, proper technique is crucial to getting accurate temperature readings. Please read this manual thoroughly and carefully before using.
- Always operate the thermometer in an operating temperature range 10°C to 40°C (50°F to 104°F), and relative humidity less than 95%.
- Always store the thermometer in a cool and dry place: temperatures between -20°C to 60°C (-4°F to 140°F) relative humidity less than 95%. Avoid direct sunlight.
- Avoid dropping the thermometer from a height or strongly hitting it with a hard object.
- For proper hygiene, do not re-use probe cover. Damaged probe cover may result in error display.
- Do not disassemble the thermometer.
- Basic safety precautions should always be observed, especially when the thermometer is used on or near children and disabled persons.
- This thermometer is not intended to be a substitution for consultation with your physician.
- The skin/surface scan temperature serves as a reference only. It cannot be a judgment on fever.
- Temperature of left and right ear may differ. Always measure by using same ear.

## Restrictions of Use

This thermometer is clinically proven to produce accurate temperature measurements. However, please be advised if you have the following situations:

- The accuracy cannot be ensured for a person who has deformity in the ear such that the thermometer probe cannot be properly inserted into the ear canal.
- The accuracy cannot be ensured when blood or drainage is found in the ear canal.
- Take temperature from the other ear if ear drops or medications have been placed in an ear.
- For a person who wears ear plug or hearing aid, remove the device and wait for 15 minutes before taking temperature.

### NOTE:

- ▶ Never try to clean inside the ears. You may accidentally damage the eardrum or its surrounding tissues. Remove excess earwax only when you can reach it with a clean cloth. Consult a physician if you suspect the presence of excess earwax.

## Intended Use

This innovative medical device relies on advanced infrared (IR) technology to measure temperature instantly and accurately from the ear canal.

Our ear thermometer is intended for the intermittent measurement and monitoring of human body temperature from ear canal.

## How Does it Work

The thermometer measures the infrared heat generated by the eardrum and its surrounding tissue, or by the surface of the skin over the temporal artery. The thermometer then converts it into a temperature value shown on LCD.

The reference body site is oral temperature.

### NOTE:

The thermometer does not emit any infrared signal.

## Thermometer Parts

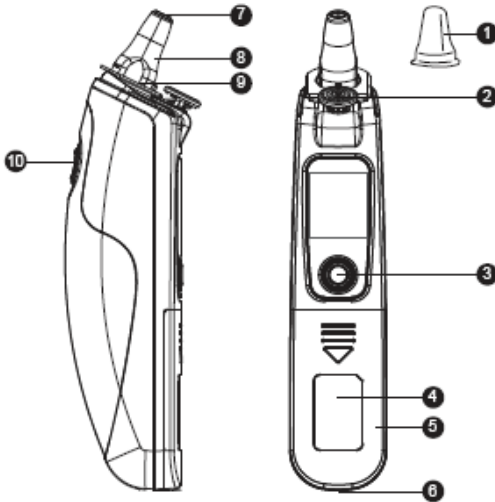

- Probe cover
- Probe cover ejection button
- On/Memory button
- Manufacturing label
- Battery cover
- Data port
- Probe lens
- Probe
- Probe cover detector
- Scan button

## LCD Screen

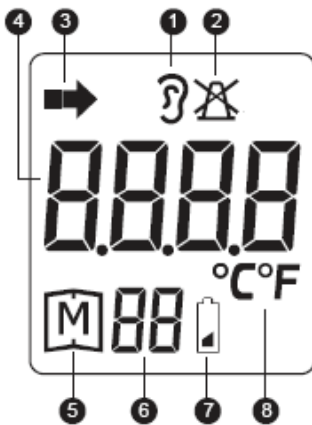

1. Ear temperature indicator
2. Probe cover missing
3. Temperature scanning in progress
4. Temperature display
5. Memory mode
6. Record numbers
7. Low battery indicator
8. Temperature unit

## Replacing the Battery

The thermometer comes with two 1.5V AAA alkaline batteries. Replace it when “” appears. Please follow the steps to replace new batteries.

**Step 1**

Remove the battery cover.



**Step 2**

Place the new battery in the battery compartment and press it in until the batteries are firmly secured.



**Step 3**

Reattach the battery cover.



**NOTE:**

- ▶ Although the thermometer works when “ appears, we still recommend that you change the batteries to obtain an accurate result.
- ▶ Remove the batteries if stored for a long period of time.
- ▶ The batteries should be kept out of reach of children. If they are swallowed, promptly see a doctor for help.

**Using the Device**

**Step 1.**

**Apply a new probe cover.**

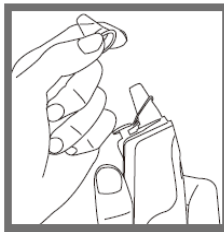

**Step 2.**

**Turn on the thermometer.**

Press and release the On / Memory button. When ready, the thermometer displays the last measurement.

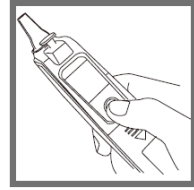

**Step 3.**

**Gently fit the probe into the ear canal.**

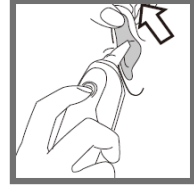

**Step 4.**

**Press and release the Scan button.**

Do not remove the thermometer until it beeps.

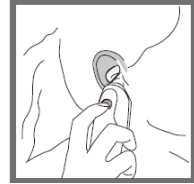

**Step 5.**

**Read the result.**

“” is shown together with a temperature value.



**Step 6.**

**Eject the used probe cover.**

Eject the used probe cover into trashcan by pushing the lens filter ejection button.

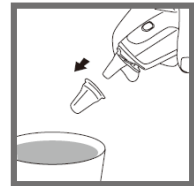

**NOTE:**

- ▶ Turn off the thermometer by pressing On / Memory button twice. It will automatically turn off if left idle for 3 minutes.
- ▶ If you need to take another reading, wait “” flashing before taking another measurement.
- ▶ The recommended minimum measuring time is one (1) second; the minimum time between each measurement is four (4) seconds.
- ▶ The thermometer does not send out any infrared signal. The thermometer is an adjusted mode clinical thermometer.

**Warning:**

- ▶ Use only recommended probe covers. Using other manufacturers' probe covers may result in inaccurate temperature measurements or monitor errors.
- ▶ Always apply a new probe cover before taking a measurement.

## Recalling the Memory

Your thermometer stores 10 recent readings in the memory.

### Step 1

Be sure the thermometer is OFF before recalling this memory.

### Step 2

Press the On / Memory button to turn on the thermometer.



### Step 3

Press the On / Memory button for 3 seconds to enter memory mode.

Each time you press the On / Memory button, a result will be displayed in the order of dates (latest result shown first), together with "M" and number (from 1 to 10).

When the memory is full, the oldest result is deleted as the new one added. When the last record is displayed in the LCD, press On/Memory button again to return the first record.



### Step 4

Exit the memory. Press the Scan button and LCD will show latest results with flashing "▶". Then press On / Memory button twice to exit the memory.

## Care & Cleaning

The probe is not waterproof. Please wipe with a clean and dry cotton swab to clean the probe on the inside.

The body of the thermometer is not water-resistant. Never put the thermometer under a running tap or submerge it into water. Use a soft and dry cloth to clean it. Do not use abrasive cleaners.

Store the thermometer in a cool and dry location. Free from dust and away from direct sunlight.

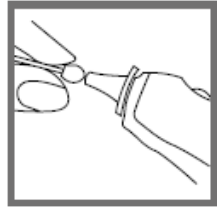

### **NOTE:**

- ▶ The thermometer is initially calibrated at the time of manufacture. If this thermometer is used according to the use instructions, the accuracy of measures will not be affected, if at any time you questions the accuracy of the temperature measurement, please contact service center.

## ALARM AND MESSAGE

The monitor provides both audible and visible alarm indicators to alert the operator of system status changes and physiological parameter alarms.

Alarms are provided for all monitored parameters. Each parameter limit alarm condition triggers both audible and visible alarms until one of the following events occurs:

- The parameter value returns to within the alarm limit.
- The alarm limit is set beyond the present parameter value.
- The SILENCE key is pressed. (Audible alarms only)

### Audible Alarms

The high priority alarm consists of a pair of bursts. Each burst consists of five tone pulses. The pair of bursts repeats every 5 seconds and sound 57 dB. The alarm indicator will light up red, if the alarm button is pressed.

### Visible Alarms

The monitor provides visible text alarms on the interface display screen. If a physiological parameter exceeds the high limit or falls below a low limit value, the numerical value will flash red.

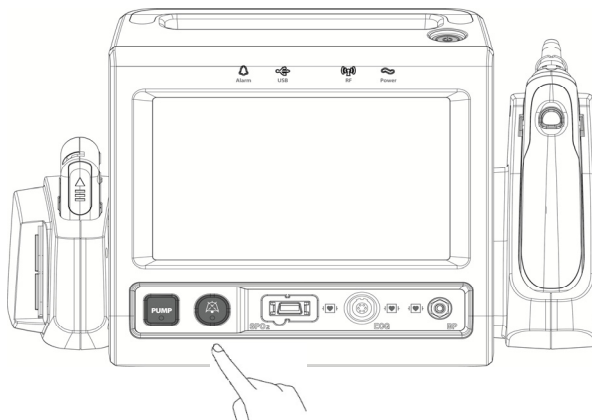

## Alarm silence key



The alarm cannot be turned off, but can be temporarily silenced by pressing the SILENCE key. The recovery time is 2 minutes.

### Response for the operator after the Alarm is triggered

#### High priority alarm signal:

The operator should stop his/her task at hand immediately and investigate the cause of the alarm.

#### Low priority alarm signal:

The operator may not be interrupted however the operator is able to investigate the cause of the alarm at later time.

### Alarm Message List

Alarms and messages for heart rate may be generated by the ECG, SpO<sub>2</sub> or the NIBP module.

For visual alarm only: NIBP, Temperature and Blood Glucose.

For both visual and audible alarm: Heart Rate, SpO<sub>2</sub> and ECG.

	Alarm	Priority	Description
HEART RATE	LOW (audible and visual alarm)	High	The heart rate value has dropped below the value set in the menu.
	HIGH (audible and visual alarm)	High	The heart rate value has exceeded the value set in the menu.
SpO <sub>2</sub>	LOW SpO <sub>2</sub> (audible and visual alarm)	High	The SpO <sub>2</sub> value has dropped below the value set in the menu.
	HIGH SpO <sub>2</sub> (audible and visual alarm)	High	The SpO <sub>2</sub> value has exceeded the value set in the menu.
NIBP	HIGH SYS (Visual alarm)	Low	The systolic value has exceeded the value set in the menu.
	LOW SYS (Visual alarm)	Low	The systolic value has dropped below the value set in the menu.
	HIGH DIA (Visual alarm)	Low	The diastolic value has exceeded the value set in the menu.
	LOW DIA (Visual alarm)	Low	The diastolic value has dropped below the value set in the menu.
	HIGH MAP (Visual alarm)	Low	The mean arterial pressure value has exceeded the value set in the menu.
	LOW MAP (Visual alarm)	Low	The mean arterial pressure value has dropped below the value set in the menu.

<b>Temperature</b>	HIGH TEMP (Visual alarm)	Low	The temperature value has dropped below the value set in the menu
	LOW TEMP (Visual alarm)	Low	The temperature value has dropped below the value set in the menu
<b>BG (Blood Glucose)</b>	HIGH (Visual alarm)	Low	The BG value has dropped below the value set in the menu
	LOW (Visual alarm)	Low	The BG value has dropped below the value set in the menu

	<b>Information signal</b>	<b>Description</b>
<b>SpO<sub>2</sub> Probe OFF</b>	Warning Tone	The SpO <sub>2</sub> sensor is missing or defective. Connect or replace the sensor.
<b>ECG Lead OFF</b>	Warning Tone	The ECG lead is off. Check electrodes, lead wires, and cables. If necessary, change to a different lead.
<b>Battery Low</b>	Warning Tone	Low battery warning.

**NOTE:**

► The warning tone will be displayed for all pages (Ex. Lead Off, Probe Off or Battery Low).

## TAKING CARE OF THE MONITOR

### NOTE:

- ▶ Before performing any maintenance or service to the monitor, disconnect the AC power line from the electrical outlet.
- ▶ Store the monitor at -20 °C ~ to 60 °C (-4 °F to 140 °F), 10% to 85% relative humidity.
- ▶ Avoid dropping and direct sunlight and humidity.

## Cleaning/ Disinfection

### Vital-Signs Monitor

When necessary, clean the monitor with a cloth slightly dampened with 70% isopropyl alcohol / mild detergent / water (Do not use corrosive liquids). Never immerse the monitor and accessories in any type of liquid.

### Blood Pressure Cuff

Clean the blood pressure cuff with a damp cloth, or wash in water with soap or detergent. Before washing the blood pressure cuff, remove the tube. After washing, allow the blood pressure cuff to air dry.

### Cables and Pressure Hose

Wipe the cabling and pressure hose with a damp cloth moistened in a mild detergent solution. Do not immerse.

## Temperature Sensor

Periodically wipe the temperature sensor clean with an alcohol-dampened cloth, warm water, or properly diluted, non-staining disinfectant. Do not immerse the sensor.

## SpO<sub>2</sub> Sensor

Clean the reusable SpO<sub>2</sub> sensor with a 70% isopropyl alcohol solution and allow to air dry. Do not immerse the sensor or cable.

Every 3 months, inspect the temperature sensor, SpO<sub>2</sub> sensor, and accessories for fraying or other damage.

Replace as necessary.

## Battery Removal and Replacement

As necessary, replace the internal battery after heavy use or the battery no longer charges. Use a battery with the same part number.

1. Turn the monitor off and disconnect the AC power cord.
2. Remove the screws holding the battery door using a Phillips-head screwdriver and then remove the battery door to expose the battery.
3. Disconnect and discard the old battery per local regulations. Reconnect the new battery as soon as possible to prevent loss of power to the unit and subsequent loss of clock time.
4. Slide the new battery completely into the compartment. Lay the connector on the battery.
5. Replace the battery door and tighten each of the screws.

## SpO<sub>2</sub> Accessory Disposal

Dispose of all finger sensors and cables in accordance with facility, local, and government regulations.

## ECG Accessory Disposal

Dispose of all ECG electrode pads in accordance with facility, local, and government regulations.

## Battery or Probe Cover disposal



Adhere to the applicable regulations when disposing of the device.

This product must not be disposed of together with domestic waste, All users are obliged to hand in all electrical or electronic devices, regardless of whether or not they contain toxic substances at a ,municipal or commercial collection point so that they can be disposed of in an environmentally acceptable manner.

Please remove the batteries before disposing of the device/unit.

Do not dispose of old batteries with your household waste, but at a battery collection station at a recycling site or in a shop.

## Technical Assistance

If you have an equipment problem that you cannot resolve, call the representative who you purchased the monitor from.

**Note:**

- ▶ Both the monitor and the battery can be recycled. When you wish to dispose of the monitor or are replacing the battery, please recycle according to your local regulations.

## ERROR MESSAGES





### Blood Pressure Measurement Error Messages

	Error Message Definitions	Recommends correction
<b>Error 01</b>	Cuff serious leakage or Inflation too slow.	Check Cuff and connector
<b>Error 02</b>	Amplitude is enlarged over 4x than the previous 2 Amplitudes.	Pump again
<b>Error 03</b>	Cuff pressure is too high.( > 300mmHg)	Check tube and pump again
<b>Error 04</b>	No pulse or Detected pulse count less than 3	Pump again
<b>Error 05</b>	There is no pulse detected before/after I <sub>max</sub>	Check cuff and connector
<b>Error 06</b>	Pulse Amplitude is too large & Saturated.	Pump again
<b>Error 07</b>	Pressure Sensor is failed for 0 or 4095 zero AD	Check cuff and connector. If still occur, please call service
<b>Error 08</b>	system keeps re-pumping over 2 times	Pump again
<b>Error 09</b>	Cuff cannot deflation or deflation is too slow	Pump again

### SpO<sub>2</sub> Measurement Error Messages

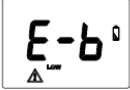
Message	Cause	What to do
Please check the probe!	The probe is sensing any object.	Re-click the patient's finger or try the other fingers
Probe disconnect!	Oximeter probe is not connected.	Check the probe connection
Initial SpO <sub>2</sub> !	When booting up, the SpO <sub>2</sub> module is in initiation process.	Wait for the initiation process to finish.

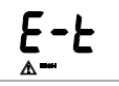
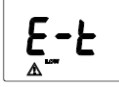
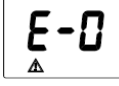
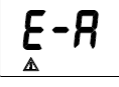
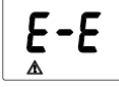











## Blood Glucose Measurement Error Messages

MESSAGE	WHAT IT MEANS	WHAT TO DO
	Appears when the batteries are too low.	Replace the batteries immediately.
	Appears when a used test strip is inserted.	Repeat with a new test strip.
	Appears when ambient temperature is above system operation range.	System operation range is 10°C to 40°C (50°F to 104°F). Repeat the test after the meter and test strip are in the above temperature range.
	Appears when ambient temperature is below system operation range.	
	Problem with the meter.	Repeat the test with a new test strip. If the meter still does not work, please contact the customer service for assistance.
		
		
	Appears when test strip is removed while counting down, or insufficient blood volume.	Review the instructions and repeat test with a new strip. If the problem persists, please contact the local customer service for help.

## Ear Temperature Measurement Error Messages

**NOTE:**

► The error messages are displayed on the infrared thermometer.

Message	What it means	What to do
	Room temperature is below 10°C	Put the thermometer under operating temperature range of 10°C to 40°C
	Room temperature is below 40°C	Put the thermometer under operating temperature range of 10°C to 40°C
 	You don't use probe cover while measuring ear temperature.	Please place probe cover into probe again.
   	Problem with the thermometer.	Review the instructions and re-start the measurement procedure. If the above step do not work. Please contact the agent.
	Battery is low and “  ” appears on LCD.	Please replace batteries as soon as possible.
	Appears when the batteries cannot provide enough power for a test.	Please replace new batteries.
 	Temperature measurement fails outside the displayed temperature range: (ear temperature range from 32°C to 43°C)	Please follow this manual to take a reading again.

## SPECIFICATIONS

Blood Pressure	
Cuff Pressure Range	0 mmHg to 300 mmHg
Measurement Method	Adult and Pediatric mode (Clever Inflation or Deflation) Neonate mode (Deflation Only)
Systolic range	60 ~ 255 mmHg (Adult & Pediatric) 50 ~ 125 mmHg (Neonate)
Diastolic range	30 ~ 180 mmHg(Adult & Pediatric) 20 ~ 85 mmHg(Neonate)
MAP range	40 ~ 210 mmHg(Adult & Pediatric) 30 ~ 100 mmHg (Neonate)
Max. Pressure	300 mmHg(Adult & Pediatric) 150 mmHg (Neonate)
Resolution	1mmHg
Static Pressure Accuracy	±3mmHg over full range
Automatic Cycles	OFF, 3min, 5 min, 10 min, 15 min 30 min, 1 hr, 1.5 hr ,2 hr, 4Hr
Heart Rate Range	30 ~ 240 beats/min
Heart Rate Accuracy	± 3 bpm
STAT mode function	Continuous measurements in 5 minutes
Suggested Cuff Size	The suggested cuff sizes are classified as below: Infant = Arm Circumference 9 ~ 14cm Child = Arm Circumference 13 ~ 21 cm Small Adult = Arm Circumference 18 ~ 26 cm Adult = Arm Circumference 25 ~ 35 cm Large Adult = Arm Circumference 33 ~ 47 cm Thigh = Thigh Circumference 46 ~ 66 cm

<b>SpO<sub>2</sub></b>	
Display update interval	1 second
Measuring Range	30% ~ 100%
Accuracy	70% to 79% ± 3%, 80% to 100% ±2%, others are undefined.
Heart Rate range	30 ~ 250 beats/min
Heart Rate Accuracy	± 3 bpm
Measuring Principles	Dual wavelength LED
Audio	Tone with each detected pulse; pitch varies with saturation
<b>Heart (Pulse) Rate</b>	
Method	Select measuring the pulse rate by BPM, SpO <sub>2</sub> , ECG in Menu
Measuring Range	30 to 250bpm
Update Time	Every second(for SpO <sub>2</sub> measuring)
Resolution	1bpm
<b>ECG</b>	
Vertical Scales	5, 10 mm/mV
Sweep Speed	25 or 50 mm/sec (Selectable for Print out only)
DC Offset Correction	± 300mV
Signal Sampling Resolution	600 samples/sec (with 12-bit ADC)
Heart Rate Range	30 ~ 250 beats/min
Heart Rate Accuracy	± 3 bpm
<b>Blood Glucose</b>	
QC function	Built in BG meter
Interface	IrDA communication with main unit
Power source	Battery AAx2
<b>Temperature</b>	
Measurement Type	Infrared thermometer
Display Range	32°C to 43°C (89.6°F to 109.4°F)
Accuracy	35.0 °C ~ 42.0 °C ± 0.2 °C; Others during the measuring range ± 0.3 °C

Interface	IrDA communicate with main unit
Power source	Individual battery("AAA" type)
<b>Alarms</b>	
Indication Method	Audible and Visual
Sound Volume	57dB
Silence Option	Yes; 2 minutes (press once) or permanent (press and hold)
<b>Displays</b>	
Display Type	7" TFT-LCD with touch-screen(resister type)
Parameters	Vital signs: NIBP, SpO <sub>2</sub> , ECG, BG, Temperature, Pulse Rate, Pulse Bar, Patient data: ID, Weight, High, Respiration, Patient Size ,Reading Number, other comments(from doctor ,nurse) System : Date, Time, Battery Status, Location
Status Indication	Alarm Silence; Sensor; Low Battery, Charging state, External Power
Patient Data Management	Allow to recall the patient data and record the patient conditions, such as patient name, ID, height, weight, and respiration condition.
Languages(U.I.)	English / 繁體中文 / 简体中文 / 日本語
<b>Printer</b>	
method	Thermal line dot printing
resolution	384 dots/line , 8 dots/mm
Paper width, type	58 mm , rolling type
Paper loading	Easy paper operation
Power source	1. Build-in Li battery(7.2V), charge from main unit 2. DC-9V adapter
Interface	Serial RS-232 with main unit and charging
<b>Barcode Reader</b>	
Illumination	630nm LED
Receiving	3648 element linear
Reading distance	2.5 ~20 cm

Reading width	5 in. code width at 7 in.
Skew Angle	±55°
Resolution	3 mi. at 3.5" distance
Decode rate	270 decodes/sec.
Interface	Serial PS/2 connector with main unit
<b>Mechanical</b>	
Dimensions	309H x190 W x 190 D(mm)
Weight	2.5 Kg ,including accessory and battery
Mounting Option	Mobile Stand and Wall Mount
Portability	Hand-carried by the top handle
Memory Capacity	8GB or 16GB or 32GB SD card
<b>Power Requirements</b>	
Input source:	AC 100~240V, 47~63Hz
Main Unit Battery	7.4V 4600 mAh-----Rechargeable Li-ion Battery; Operation time: 8 hours (with backlight DIM=4) ,Charging time: 5 hours
<b>Environmental</b>	
Operating Temperature	10 °C ~ +40 °C ( 50 °F ~ 104 °F)
Storage Temperature	-20 °C ~ +60 °C ( -4 °F ~ 140 °F)
Operating Humidity	R.H. 10% ~ R.H. 85%; No Condensation
Storage Humidity	R.H. 10% ~ R.H. 85%; No Condensation
<b>Classification</b>	
Type of Protection	Class I equipment
Degree of Protection	Type CF defibrillator-proof equipment
Protection against Ingress	IPX2 rating, Drip-Proof Equipment
<b>Harmonized Standard</b>	
	ISO 13485:2016  EN ISO 14971:2012

EN ISO 15197:2015

EN ISO 15223-1 :2016

EN ISO 18113-1:2011

EN ISO 18113-2:2011

EN ISO 18113-3:2011

EN ISO 23640:2015

EN 1041:2008+A1:2013

EN 50581:2012

EN 61010-1:2010

EN 61010-2-101:2016

EN 61326-1:2013

EN 61326-2-6:2013

EN 62304:2006+A1:2015

EN 62366-1:2015

2011/65/EU

ISO 10993-5:1999

ISO 10993-10:2002

ISO 10993-12:2007

EN ISO 14155:2011

EN ISO 15223-1:2012

EN ISO 80601-2-56:2012

EN ISO 80601-2-61:2011

EN ISO 81060-1:2012

EN ISO 81060-2:2014

EN 1060-3:1997+A2:2009

EN 1060-4:2004

EN 60601-1:2006+A1:2013

EN 60601-1-2:2007+AC:2010

EN 60601-1-8:2006+Am.1:2012









IEC 60601-2-27:2011







IEC 60601-2-49:2011

IEC 62133:2002

EN 80601-2-30:2010+A1:2015

## SYMBOL

Symbol	Definition
	Caution
	CE mark
	Authorized representative in the European Community
	Alarm
	Defibrillation-proof type CF applied part
<p data-bbox="165 995 226 1021"><b>IPX2</b></p>	Resistant to liquid ingress
	Serial number
	<i>In vitro</i> diagnostic medical device
	Refer to instruction manual/ booklet NOTE On ME EQUIPMENT "Follow instructions for use"

	<p>Catalogue number</p>
	<p>This device does not belong to household waste and must be returned to a collection point for recycling electric and electronic devices according to local laws. If it contains batteries, the batteries should be removed and disposed in accordance with local regulations for separate collection of spent batteries.</p>
	<p>Alternating current</p>
	<p>Do not use if package is damaged</p>
	<p>Keep dry</p>
	<p>Temperature limit</p>
	<p>Class II equipment</p>

## IMPORTANT INFORMATION REGARDING ELECTRO MAGNETIC COMPATIBILITY (EMC)

Medical devices manufactured by TD-2300 vital signs monitor conform to this IEC60601-1-2 standard for both immunity and emissions. Nevertheless, special precautions need to be observed:

- The use of accessories and cables other than those specified by TD-2300, with the exception of cables sold by TD-2300 vital signs monitor as replacement parts for internal components, may result in increased emission or decreased immunity of the device.
- The medical devices should not be used adjacent to or stacked with other equipment. In case adjacent or stacked use is necessary, the medical device should be observed to verify normal operation in the configuration in which it will be used.
- Do not use mobile (cellular) telephones and other devices, which generate strong electrical or electromagnetic fields, near the medical device. This may result in incorrect operation of the unit and create a potentially unsafe situation. Recommendation is to keep a minimum distance of 7 m. Verify correct operation of the device in case the distance is shorter.

The TD-2300 is intended for use in the electromagnetic environment specified below. The customer or the user of the TD-2300 should assure that it is used in such environment.

Electromagnetic emissions IEC60601-1-2		
Emissions test	Compliance	Electromagnetic environment - guidance
RF emissions CISPR 11	Group 1	The vital signs monitor uses RF energy only for its internal function. Therefore, its RF emissions are very low and are not likely to cause any interference in nearby electronic equipment
RF emissions CISPR 11	Class A	The vital signs monitor is not suitable for use in Residential and domestic establishments and those directly connected to the public low-voltage power supply network that supplies buildings used for domestic purposes.
Harmonic emissions IEC 61000-3-2	None	
Voltage fluctuations/ flicker emissions IEC 61000-3-3	None	

**Electromagnetic immunity IEC60601-1-2**

<b>Immunity test</b>	<b>IEC 60601 Test level</b>	<b>Compliance level</b>	<b>Electromagnetic environment – guidance</b>
Electrostatic discharge (ESD) IEC 61000-4-2	±6KV contact ±8KV air	±6KV contact ±8KV air	Floor should be wood, concrete, or ceramic tile. If floors are covered with synthetic material, the relative humidity should be at least 30%.
Electrical fast transient/burst IEC 61000-4-4	±2KV for power supply lines ±1KV for input/output lines	±2KV for power supply lines *1)	Mains power quality should be that of a typical commercial and/or hospital environment.
Surge IEC 61000-4-5	±1KV line to line ±2KV line to earth	±1KV line to line ±2KV line to earth	Mains power quality should be that of a typical commercial and/or hospital environment.
Voltage dips, short interruptions and voltage variations on power supply IEC 61000-4-11	<5 % <i>UT</i> (>95 % dip in <i>UT</i> ) For 0.5 cycle	<5 % <i>UT</i> (>95 % dip in <i>UT</i> ) For 0.5 cycle	Mains power quality should be that of a typical commercial and/or hospital environment.  If the user of the vital signs monitor requires continued operation during power mains interruption, it is recommended that the vital signs monitor be powered from an uninterruptible power supply or battery.
	40 % <i>UT</i> (60 % dip in <i>UT</i> ) for 5 cycles	40 % <i>UT</i> (60 % dip in <i>UT</i> ) for 5 cycles	
	70 % <i>UT</i> (30 % dip in <i>UT</i> ) for 25 cycles	70 % <i>UT</i> (30 % dip in <i>UT</i> ) for 25 cycles	
	<5 % <i>UT</i> (95 % dip in <i>UT</i> ) for 5 sec.	<5 % <i>UT</i> (95 % dip in <i>UT</i> ) for 5 sec.	
Power frequency (50/ 60 Hz) magnetic field IEC 61000-4-8	3 A/m	3 A/m	Power frequency magnetic fields should be at levels characteristic of a typical location in a typical commercial or hospital environment.

Note: *UT* is the A.C. mains voltage prior to application of the test level.

\*1) The test of input/output lines is not applicable since they are shorter than 3.0m.

## Recommend separation distance

The following list where  $P$  is the maximum output power rating of the transmitter in watts (W) according to the transmitter manufacturer and  $d$  is the recommended separation distance in meters (m).

Field strengths from fixed RF transmitters as determined by an electromagnetic site survey,\*2) should be less than the compliance level in each frequency range.\*3)



Interference may occur in the vicinity of equipment marked following symbol:

Electromagnetic immunity IEC60601-1-2			
Immunity test	IEC 60601 Test level	Compliance level	Electromagnetic environment – guidance
Conducted RF IEC 61000-4-6	3 V rms 150 kHz ~ 80 MHz	3 V rms	Recommend separation distance $d = 1.2 \sqrt{P}$
Radiated RF IEC 61000-4-3	3 V/m 80 MHz to 2.5 GHz	3 V/m	Recommend separation distance $d = 1.2 \sqrt{P}$ 80 MHz to 800 MHz $d = 2.3 \sqrt{P}$ 800 MHz to 2.5 GHz

Note1: At 80 MHz and 800 MHz, the higher frequency range applies.

Note2: These guidelines may not apply in all situations. Electromagnetic propagation is affected by absorption and reflection from structures, objects, and people.

\*2) Field strengths from fixed transmitters, such as base stations for radio (cellular/ cordless) telephones and land mobile radio, AM and FM radio broadcast, and TV broadcast cannot be predicted theoretically with accuracy. To assess the electromagnetic environment due to fixed RF transmitters, an electromagnetic site survey should be considered. If the measured field strength in the location in which the vital signs monitor is used exceeds the applicable RF compliance level above, the vital signs monitor should be observed to verify normal operation. If abnormal performance is observed, additional measures may be necessary, such as reorienting or relocating this unit.

\*3) Over the frequency range 150 kHz to 80 MHz, field strengths should be less than 3 V/m.

## Recommended separation distance between portable and mobile RF communications equipment and the vital signs monitor

The vital signs monitor is intended for use in an electromagnetic environment in which radiated RF disturbances are controlled. The customers or the users of the vital signs monitor can help prevent electromagnetic interference by maintaining a minimum distance between portable and mobile RF communications equipment (transmitters) and the vital signs monitor as recommended below, according to the maximum output power of the communications equipment.

	Separation distance according to frequency of transmitter in meter		
	150 kHz to 80 MHz $d = 1.2 \sqrt{P}$	80 kHz to 800 MHz $d = 1.2 \sqrt{P}$	800 MHz to 2.5GHz $d = 2.3 \sqrt{P}$
<b>Output Power of Transmitter in Watt</b>	separation distance in meters (m)	separation distance in meters (m)	separation distance in meters (m)
0.01	0.1(0.4)	0.1(0.4)	0.2(0.7)
0.1	1.4(1.1)	1.4(1.1)	0.7(2.2)
1	1.3(3.5)	1.3(3.5)	2.3(7.0)
10	3.8(11.1)	3.8(11.1)	7.3(22.1)
100	12.0(35.0)	12.0(35.0)	23.0(70.0)
<p>For transmitters rated at a maximum output power not listed above, the recommended separation distance <math>d</math> in meters (m) can be estimated using the equation applicable to the frequency of the transmitter, where <math>P</math> is the maximum output power rating of the transmitter in watts (W) according to the transmitter manufacturer.</p> <p>Note: At 80MHz and 800MHz, the separation distance for the higher frequency range applies</p> <p>Note: These guidelines may not apply in all situations. Electromagnetic propagation is affected by absorption and reflection from structures, objects, and people.</p>			

### Note:

- If you need USB / Bluetooth protocol information, please contact your agent for details.







**TaiDoc Technology Corporation**

B1-7F, No. 127, Wugong 2nd Rd., Wugu Dist., 24888 New Taipei City, Taiwan

[www.taidoc.com](http://www.taidoc.com)



**MedNet EC-REP GmbH**

Borkstraße 10, 48163 Münster, Germany

